

Instruction Manual

for

MARCONI MARINE

OCEANIC

GP/SSB RECEIVER

© The Marconi International Marine Company Limited 1984

Published by

Technical Information Section
THE MARCONI INTERNATIONAL MARINE COMPANY LIMITED
Elettra House, Westway, Chelmsford (CM1 3BH), Essex, England.

A GEC-Marconi Electronics Company

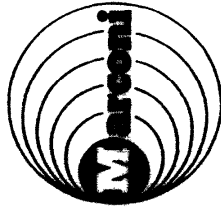

M3000 Oceanic

General Coverage Communications Receiver

Digital Solid State

Made in England 1982

Features:

S-Indicator, RF Gain, Notch, BFO, Memories, Attenuator, AGC, 4 bandwidths, Scanning, ¼" Headphone Jack, Atten. -20 dB, Dimmer, Keypad and Rack Handles. Coverage is from 15 - 30000 kHz to 10 Hz in: AM/CW/SSB/RTTY/FAX. Presets for 500 & 2182 kHz. Has Line and IF out. Modular construction.

Comment: For maritime use. See Dansk M3000.



Dansk Radio AS



RX4000

General Coverage Communications Receiver
Double Conversion Superheterodyne. Solid State.

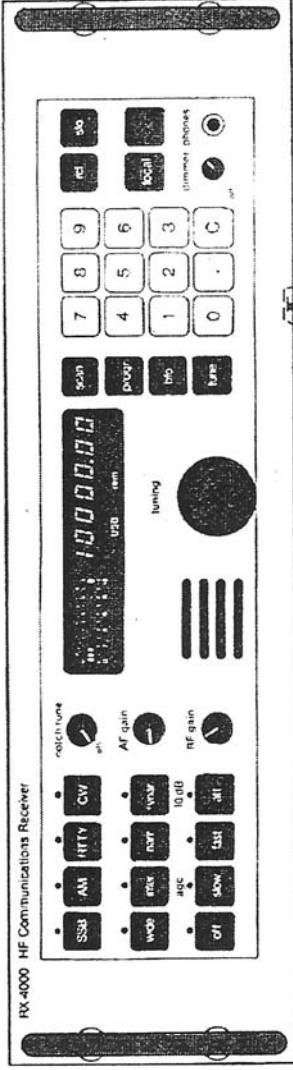

Features:

- 1/4" Head. Jack
- RF Gain
- Mute Line
- AGC
- Squelch
- Dial Lock
- S-Indicator
- IF Out Jack
- 75 Memories
- Ext. Spkr Out
- Clock
- Speaker
- Line Out 600 ohm
- Scan & Sweep
- 1.4 MHz IF Out Jack
- Rack Handles
- Sidetone Input
- 3 Tuning Rates

Specifications:

Coverage 15 - 30000 kHz Modes AM/SSB/CW/RTTY
Selectivity 5.4/2.4/1/2 kHz -6 dB. Stability ±.1 PPM -15° to 45° C.
Sensitivity <2µV 20 dB SINAD SSB IF Rejection >90 dB
Image Rej >90 dB Environment ... 0° to +50° C.
Audio Out 4 W 4 ohms Antenna Input . BNC 50 ohm

Accessories:

471666 RS232 600/1200 bps 463302 RS232 9600 bps
471577 RTTY Demod. 475246 Cabinet

Comments:

Operation from 15 to 100 kHz with reduced performance. The RX4000 has 175 pre-programmed CCIR SSB channels and 257 pre-programmed CCIR-RTTY channels. The memories store frequency, mode, bandwidth, AGC setting, RF attenuation and BFO frequency and have battery backup. During scanning or sweeping, the dwell time can be set from .1 to 9 seconds. The clock can set for up to 24 alarms per day.

Made In: Denmark 1985-1991

Voltages: 110-125, 220-250 VAC
50/60Hz 70W

Readout: **000000.01** Digital

Physical: 19x5.25x18.25" 33 Lbs.
483x132x463mm 15 kg

Status: Active Manufacturer
Discontinued Model

TABLE OF CONTENTS

Section	Page
1 GENERAL INFORMATION	1-1
1.1 Introduction	1-1
1.2 Specifications	1-1
1.3 Receivers covered by this Manual	1-1
1.4 Safety Considerations	1-1
1.5 Description	1-2
1.6 Options	1-3
1.7 Accessories Supplied	1-3
1.8 Accessories Available	1-3
2 INSTALLATION	2-1
2.1 Introduction	2-1
2.2 Initial Inspection	2-1
2.3 Storage	2-1
2.4 Repacking for Shipment	2-1
2.5 Mounting Information	2-2
2.6 Power Requirements	2-2
2.7 Fuses	2-3
2.8 Power Cable	2-3
2.9 Audio Input/Output	2-4
2.10 Line Output	2-4
2.11 Control Input/Output	2-4
2.12 IF Output	2-5
2.13 Antenna Input	2-5
2.14 Installation Check-out	2-5

TABLE OF CONTENTS (cont'd)

Section	Page
3 OPERATION	3-1
3.1 Introduction	3-1
3.2 Panel Features	3-1
3.3 Power/Warm-Up	3-1
3.4 Initial Conditions	3-1
3-5 Self Test	3-1
3-6 Manual Operating Instructions	3-3
3.6.1 Clear Display	3-3
3.6.2 Entry Errors	3-3
3.7 Quick Reference Operation Instruction	3-3
3.7.1 500 kHz and 2182 kHz Operation	3-3
3.7.2 AM Operation	3-3
3.7.3 SSB, CW and RTTY Operation	3-3
3.8 Frequency Control	3-3
3.8.1 Keyed Tuning	3-3
3.8.2 Free Tuning	3-4
3.9 Function Keys	3-4
3.9.1 Reception Mode	3-4
3.9.2 AGC Control	3-4
3.9.3 Bandwidth Control	3-5
3.9.4 Distress Keys	3-5
3.10 Storing and Recalling Receiver Settings	3-5
3.10.1 Storing Receiver Settings	3-5
3.10.2 Recalling Receiver Settings	3-5
3.10.3 Using the Rø Register	3-6
3.11 Automatic Channel Selection	3-6
3.11.1 Channel Selection	3-6
3.11.2 International Calling Channels	3-6
3.11.3 Optional Customer Defined Channels	3-6
3.12 Automatic Scanning	3-6
3.12.1 Scanning International Channels	3-7

TABLE OF CONTENTS (cont'd)

Section	Page
3.12.2 Scanning User-Defined Frequencies	3-7
3.12.3 Manual Scanning	3-7
3.13 BFO Control	3-8
3.14 AGC Threshold Control	3-8

LIST OF ILLUSTRATIONS

Figure	Page
2.1 Mains Voltage Selection	2-3
2.2 Audio Input/Output Socket	2-4
2.3 Line Output Plug	2-4
2.4 Control Input/Output Socket	2-5
2.5 Rear Panel View	2-6
3.1 Front Panel Features	3-2

LIST OF TABLES

Table	Page
1.1 Specifications	1-5
1.2 Supplemental Characteristics	1-10
2.1 Fuse Ratings	2-3
3.1 Entry errors	3-3

SECTION 1 GENERAL INFORMATION

1.1 Introduction

This Operators Manual contains information to install and operate the Marconi Marine Oceanic Receiver. A separate Service Manual is also supplied for use by a service technician to test, adjust and service the equipment.

1.2 Specifications

Receiver specifications are listed in table 1.1. These specifications are the performance standards or limits against which the receiver is tested. Table 1.2 lists supplemental characteristics. Supplemental characteristics are not specifications but are typical characteristics included as additional information for the user.

1.3 Receivers covered by this Manual

This manual applies to receivers with serial number included in the list on the title page.

Due to the experience obtained from the production and operation of the equipment, minor differences between the receiver and the manual can occur. Wherever possible such differences are covered in a "MANUAL CHANGES"

supplement, which also contains the documentation concerning the actual options in your receiver.

1.4 Safety Considerations

This manual contains information, cautions and warnings which must be followed to ensure safe operation and to maintain the receiver in a safe condition.

1.5 Description

The Oceanic communication receiver is a fully synthesized, dual conversion, superheterodyne receiver. It covers the frequency range 100 kHz to 29.9999 MHz in 10 Hz increments (optionally down to 15 kHz). Operation modes are AM, CW, RTTY and SSB.

The receiver is equipped with microprocessor control. This provides intelligence in the form of factory programmed instruction memory that introduces new concepts in communication receivers, providing improvements in performance, ease of operation and reliability.

The microprocessor control includes features such as:

- Instant push-button tuning
- Free tuning in 10 Hz to 10 kHz steps depending on the rotation speed of the tuning knob
- Battery back-up memory storage for 75 user programmable frequencies and reception modes (incl. BFO-tuning)
- Automatic receiver setting on the distress frequencies 500 kHz and 2182 kHz
- Automatic selection of all CCIR recommended frequencies for SSB and RTTY communication
- Digital keyed AGC
- AGC hold-time synchronized with SIMPLEX or ARQ burst keying
- Scanning of user-selected and CCIR frequencies
- Built-in diagnostic routines
- Error conditions automatically displayed on front panel
- AGC threshold control
- Prepared for digital selcall (option)
- Fully remote-controlled (option)

The receiver controls are arranged in groups enabling the operator to easily identify and control receiver operation with a minimum of switching. Standard settings of the AGC and bandwidth controls are automatically selected when the operator presses the desired reception mode. The operator can override all preset settings and select AGC time

constants and receiver bandwidths more suitable for his reception environment.

The receiver is equipped with a floating inverter circuit enabling the receiver to be powered either from 110/220Vac mains or 24Vdc battery.

If powered from both mains and battery, the receiver automatically selects the mains supply when available. Only during mains drop-out will the battery supply be drained.

During supply drop-out the receiver settings as well as the information contained in the user programmed memory storage is energized from a built-in battery back-up. When the drop-out is terminated, the receiver settings are automatically recalled to the front panel.

The receiver incorporates scanning facilities. During scanning the dwell time between channels is programmed by means of the normal frequency entry keyboard. Via the control input/output socket (at the rear panel of the receiver) the scan sequence may be temporarily terminated from an auxiliary decoder, enabling automatic reception of selcall communication.

When the receiver is set to the AGC-mode, the manual RF-control may be used as an AGC threshold control.

When the receiving signal exceeds the threshold level the AGC circuit in

The receiver is operated. At the same instant a digital ON signal is available at the control input/output socket, permitting external recording facilities, e.g. telex terminals or tape recorders, to be started.

Detailed operating instructions are contained in section 3 of this manual.

1.6 Options

The following options extend the usefulness of the Oceanic:

Option 001: Suboctave Filters replacing the manually tunable preselector. For a fully remote controlled receiver this option must be included.

Option 003: Duplex Filters included on the preselector board to improve reception when the receiver is used in the DUPLEX mode.

Option 004: RTTY Demodulator featuring adaptive threshold control, RS232C output and strappable baudrate and mark/space frequencies.

Option 005: Oven Stabilized Reference Oscillator for high stability reception purposes.

Option 006: Parallel Remote Control conforming to the GPIB (IEEE-488) standard interface.

Option 007: Serial Remote Control conforming to the RS232 standard interface.

1.7 Accessories Supplied

The following accessories are supplied with the Oceanic:

One Operating and Service Manual
One Operators Guide

1.8 Accessories Available

The following items are available for use with the Oceanic:

Receiver Cabinet, DRA part no. 453684

Rack Slides Kit, DRA part no. 458872

Connector Kit, DRA part no. 457914

Standard Spare Parts Kit, DRA part no. 458880

Depot Spare Parts Kit, DRA part no. 458899

Special Tools Kit, DRA part no. 458902

Table 1.1 Specifications

The below stated specifications are valid only when measured in accordance with the performance test procedures in section 4 of this manual.

FREQUENCY RANGE

100 kHz to 30 MHz in 10 Hz increments. (15 kHz to 100 kHz with reduced performance).

OPERATING MODES

A1A, A2A, H2A, A3E, H3E, R3E, J3E, (SSB mode are USB), and F1A.

FREQUENCY STABILITY (Standard version)

1 ppm 0°C to 40°C
2 ppm -15°C to +55°C
aging < 1 ppm/year

ANTENNA IMPEDANCE (Standard version)

Below 1.6 MHz : 10 Ω in series with 220 pF to 560 pF.
1.6 MHz to 4 MHz : 10 Ω in series with 250 pF
Above 4 MHz : 50 Ω .

INPUT PROTECTION

50V EMF for up to 15 minutes.

IF SELECTIVITY

R3E, J3E : Passband ripple < 2 dB
Relative att. < 6 dB within 350 Hz to 2.7 kHz
Stopband att. > 60 dB at -400 Hz and 3.7 kHz.

A1A, A2A, H2A, A3E, H3E, F1A :

Wide	:	-6 dB at \pm 2.7 kHz
Inter	:	-6 dB at \pm 1.2 kHz
Narrow	:	-6 dB at \pm 0.5 kHz
Very narrow	:	-6 dB at \pm 0.1 kHz

Table 1.1 Specifications (Continued)

SENSITIVITY (Standard version)

0.1 MHz to 1.6 MHz	:	4 μ V EMF for 10 dB SINAD in A1A/Narrow
		18 μ V EMF for 10 dB SINAD in A2A, H2A, A3E, H3E/Inter
1.6 MHz to 4 MHz	:	2 μ V EMF for 20 dB SINAD in R3E, J3E
		8 μ V EMF for 20 dB SINAD in A2A, H2A, A3A, H3E/Wide
4 MHz to 30 MHz	:	2 μ V EMF for 20 dB SINAD in R3E, J3E
		8 μ V EMF for 20 dB SINAD in A2A, H2A, A3E H3E/Wide

INTERMODULATION (Out-of-band)

100 dB μ V EMF per signal more than 30 kHz offset from tune frequency produces less than an equivalent input signal of 40 dB μ V EMF.

CROSS MODULATION

With a wanted J3E signal of 60 dB μ V EMF, an unwanted signal of 110 dB μ V EMF/30% - 400 Hz produces cross modulation output less than -30 dB relative to wanted signal level.

BLOCKING

With a wanted signal of 60 dB μ V EMF, an unwanted signal of 110 dB μ V EMF causes less than 3 dB change in output level.

ADJACENT SIGNAL SELECTIVITY

With a wanted J3E signal at the specified sensitivity limit, an unwanted signal of 80 dB μ V EMF offset -5 kHz/+8 kHz from tune frequency causes less than 6 dB change in SINAD.

IMAGE REJECTION

Greater than 90 dB.

IF REJECTION

Greater than 90 dB.

Table 1.1 Specifications (Continued)

SPURIOUS RESPONSE REJECTION

Greater than 80 dB

INTERNALLY GENERATED SPURIOUS RESPONSE

Internally generated spurious signals will not produce a S/N ratio greater than 10 dB (Inter).

SPURIOUS EMISSION

Less than 40 dB μ V/50 Ω at antenna connector.

RF ATTENUATOR

0 dB or 20 dB.

AUTOMATIC GAIN CONTROL

Less than 4 dB change in output for 100dB input signal variation from specified sensitivity limit.

Time constants A1A, R3E, J3E, F1A	:	
Attack time	:	0.5 msec. for 70 dB signal increase.
Debounce time	:	5 msec.
Attack-to-hold time :		
Wide	:	25 msec.
Inter	:	30 msec.
Narr	:	50 msec.
Vnarr	:	60 msec.
Hold time :		
Short	:	30 msec.
Long	:	1 sec.
Decay time	:	Typical 20 dB per 100 msec.
Time constants A2A, H2A, A3E, H3E	:	200 msec.

BFO RANGE

+ 7 kHz synthesized in 10 Hz steps.

Table 1.1 Specifications (Continued)

NOTCH TUNE

Typical 30 dB variable from 300 Hz to 2700 Hz.

IF OUTPUT

-20 dB/50 Ω .

LINE OUTPUT

Level : Adjustable up to +10 dBm

Impedance : 600 Ω balanced, return loss better than 20 dB

Distortion : Less than 1% in J3E

LINE INTERMODULATION (In-band)

Less than -25 dB relative to either of two 90 dB μ V EMF signals
(With RF Attenuator in "OFF").

SIDE TONE INPUT

Max. 500 mV/600 Ω

MONITOR OUTPUT

Speaker : 4W/4 Ω

Phones : 10 mW/500 Ω

MUTING

Attenuation : 60 dB typical

Attack time : 0.1 msec. typical

Decay time : 0.5 msec. typical

INPUT POWER

24 Vdc +30/-10%, 85W

110/220 Vac \pm 10%, 50/60 Hz, 100VA

OPERATING ENVIRONMENT

Temperature : Full performance range 0 $^{\circ}$ C to 50 $^{\circ}$ C

Operating range -15 $^{\circ}$ C to 55 $^{\circ}$ C

Humidity : To 95% relative humidity at 40 $^{\circ}$ C

Table 1.1 Specifications (Continued)

SPURIOUS RESPONSE REJECTION

Greater than 80 dB

INTERNALLY GENERATED SPURIOUS RESPONSE

Internally generated spurious signals will not produce a S/N ratio greater than 10 dB (Inter).

SPURIOUS EMISSION

Less than 40 dB μ V/50 Ω at antenna connector.

RF ATTENUATOR

0 dB or 20 dB.

AUTOMATIC GAIN CONTROL

Less than 4 dB change in output for 100dB input signal variation from specified sensitivity limit.

Time constants A1A, R3E, J3E, F1A	:	
Attack time	:	0.5 msec. for 70 dB signal increase.
Debounce time	:	5 msec.
Attack-to-hold time :		
Wide	:	25 msec.
Inter	:	30 msec.
Narr	:	50 msec.
Vnarr	:	60 msec.
Hold time :		
Short	:	30 msec.
Long	:	1 sec.
Decay time	:	Typical 20 dB per 100 msec.
Time constants A2A, H2A, A3E, H3E	:	200 msec.

BFO RANGE

+ 7 kHz synthesized in 10 Hz steps.

Table 1.1 Specifications (Continued)

NOTCH TUNE

Typical 30 dB variable from 300 Hz to 2700 Hz.

IF OUTPUT

-20 dB/50 Ω .

LINE OUTPUT

Level : Adjustable up to +10 dBm
Impedance : 600 Ω balanced, return loss better than 20 dB
Distortion : Less than 1% in J3E

LINE INTERMODULATION (In-band)

Less than -25 dB relative to either of two 90 dB μ V EMF signals
(With RF Attenuator in "OFF").

SIDE TONE INPUT

Max. 500 mV/600 Ω

MONITOR OUTPUT

Speaker : 4W/4 Ω
Phones : 10 mW/500 Ω

MUTING

Attenuation : 60 dB typical
Attack time : 0.1 msec. typical
Decay time : 0.5 msec. typical

INPUT POWER

24 Vdc +30/-10%, 85W
110/220 Vac \pm 10%, 50/60 Hz, 100VA

OPERATING ENVIRONMENT

Temperature : Full performance range 0 $^{\circ}$ C to 50 $^{\circ}$ C
Operating range -15 $^{\circ}$ C to 55 $^{\circ}$ C
Humidity : To 95% relative humidity at 40 $^{\circ}$ C

Table 1.1 Specifications (Continued)

Vibration : Vibration in three planes for 30 min. each
with 1 G acceleration, 5 to 50 Hz

WEIGHT

15 kg.

DIMENSIONS

See outline drawing (table 1.2).

Table 1.2 Supplemental Characteristics

FREQUENCY TUNING

Numerical frequency keyboard entry plus single knob tuning.

75 user programmable channels including mode settings.

176 pre-programmed CCIR-SSB channels.

257 pre-programmed CCIR-RTTY channels.

FREQUENCY TUNE TIME

Typical 10 msec.

BFO TUNING

Numerical frequency keyboard entry plus single knob tuning.

Default values automatically recalled when selecting reception modes.

BFO TUNE TIME

Less than 1 msec.

DISTRESS RECEPTION

500 kHz and 2182 kHz with automatic receiver settings.

INPUT SELECTIVITY (Standard version)

Tuneable preselector.

PRESELECTOR NOISE GENERATOR

Build-in noise generator for optimum preselector tuning.

AGC SYNCHRONIZATION

The AGC control is synchronized with the mute command.

AGC THRESHOLD CONTROL

Threshold continuously variable.

Control output : RS 232 positive logic for receive signals exceeding the threshold level.

Table 1.2 Supplemental Characteristics (Continued)

USER PROGRAMMABLE CHANNELS

Number of channels : 75
Channel information : Receive frequency, reception mode, bandwidth, AGC-setting, RF attenuator, and BFO frequency.
Data storage time : Greater than 5 years.

SCANNING

Scanning of user programmed channels and CCIR channels.
Scan mode : Automatic or manually by tune knob.
Dwell time : 0.1 to 9 sec. selected by keyboard entry.
Scan control : By scan stop (remote or manually) and AGC level.

SIGNAL DELAY

Signal delay from antenna input to line output :
Wide - 0.45 msec.
Inter - 0.85 msec.
Narr - 0.85 msec.
Vnar - 3.0 msec.

DIMMER CONTROL

Continuously variable.

AUTO RESTART

Retention of receiver settings during power failure.

Table 1.2 Supplemental Characteristics (Continued)

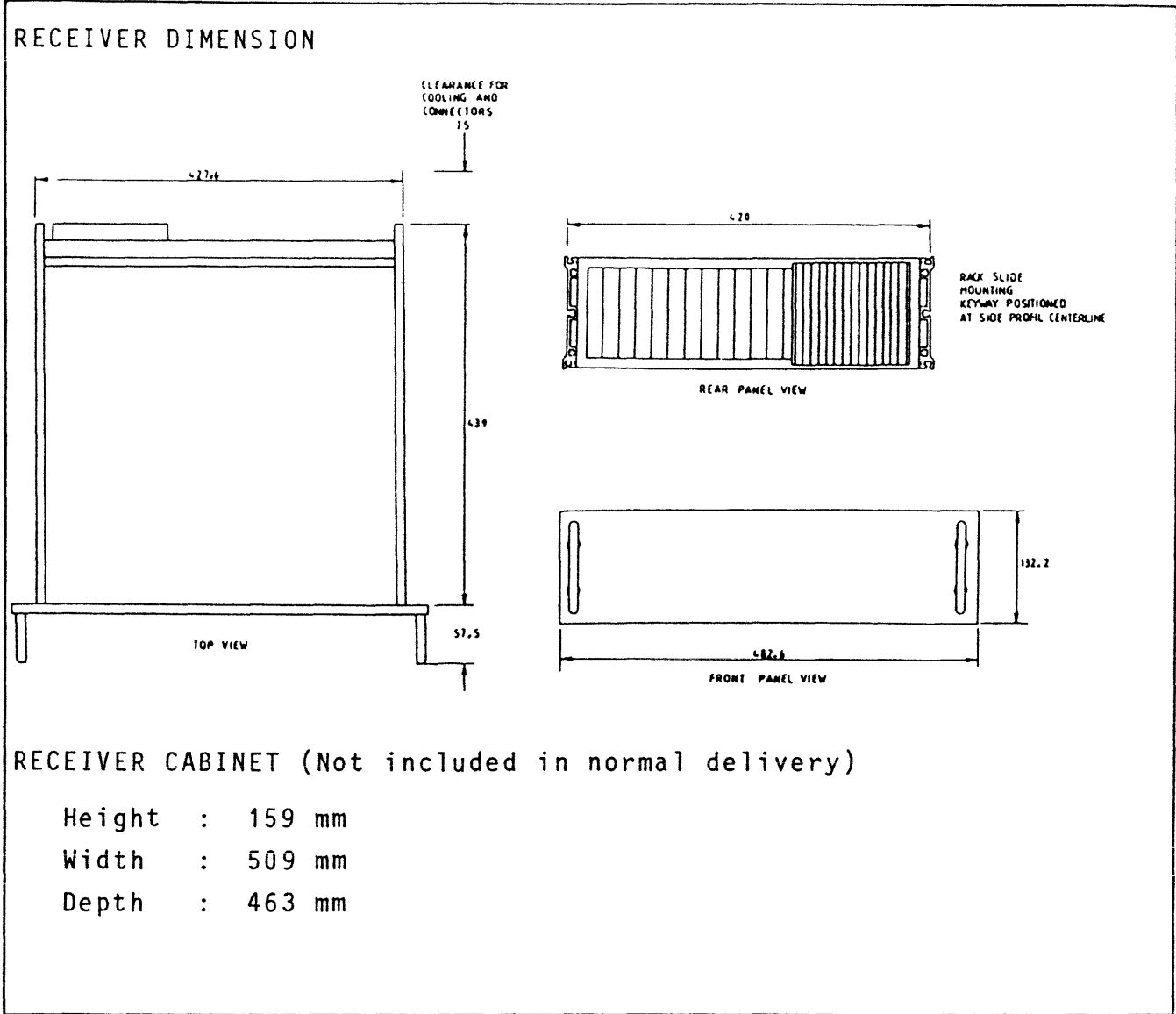

SECTION 2 INSTALLATION

2.1 Introduction

This section of the manual provides installation instructions for the Oceanic communication receiver. It also includes information about initial inspection and damage claims, preparation for use and repacking for shipment information.

2.2 Initial Inspection

WARNING

To avoid hazardous electrical shock, do not perform electrical tests when there are signs of shipping damage to any portion of the front or rear panel or outer covers. Read the safety summary at the front of this manual before installing or operating the receiver.

Inspect the shipping container for damage. If the shipping container or cushioning material is damaged, it should be kept until the contents of the shipment has been checked for completeness and the receiver has been checked mechanically and electrically. Contents of the shipment should be as listed in the "Equipment Supplied" paragraph in Section 1. If the contents are incomplete, if there is mechanical

damage or defect; or if the receiver does not pass the performance tests, notify the nearest Marconi Marine agent. If the shipping container is damaged, or if the cushioning material shows sign of stress, notify the carrier as well as the Marconi Marine agent.

A full report of the damage should also be forwarded to Marconi Marine.

Include the following:

- Order number
- Model and serial number
- Name of transportation agency

2.3 Storage

The receiver may be stored or shipped in temperatures within the limits -40°C to $+75^{\circ}\text{C}$. It is advisable to protect the receiver from extreme temperature variation which can cause excessive condensation.

2.4 Repacking for shipment

The shipping container for the Oceanic has been carefully designed to protect the receiver and its accessories during shipment. This container and its associated packing material should be used when repacking for shipment. If shipping to Marconi Marine for service, attach

a tag indicating the type of service required, return address, model number and full serial number. Mark the container FRAGILE to ensure careful handling.

If the original shipping container is not available, the following general instructions should be used for re-packing with commercially available materials:

- Wrap the receiver in heavy paper or plastic. If shipping to Marconi Marine for service, attach a tag indicating the type of service required, return address, model number and full serial number
- Use a strong shipping container eg. a double walled carton of 160 kg test material
- Protect the control panel with cardboard and insert a 7 to 10 cm layer of shock absorbing material between all surfaces of the equipment and the sides of the container
- Seal the shipping container securely
- Mark the shipping container FRAGILE to ensure careful handling

2.5 Mounting information

The receiver may be conveniently mounted in a standard 19 inch rack using a pair of rack slides or chassis angles appropriate for the rack system. The receiver in the rack mounted configuration, requires a standard panel space 5.25 inches high.

The receiver may also be mounted in a cabinet for bench operation, part no. 453684. The cabinet is designed to be mounted on a table or on a shelf, fast-

ened to the support by means of four bolts.

When operating the receiver, provide at least 75 mm clearance at the rear and at least 7 mm on all sides of the receiver. Failure to allow adequate air circulation will result in excessive internal temperature, reducing receiver reliability.

2.6 Power Requirements

The Oceanic receiver requires a power source of 110Vac (+10%) or 220Vac (+10%) 50-60 Hz single phase or 24Vdc (+30% to -10%).

The maximum power consumption is approximately 85W

CAUTION

The receiver is normally set at the factory for 220Vac and 24Vdc operation.

The selection of 110 or 220 volt nominal mains voltage is made by changing connections on terminal strip A10A2TB1 on the power supply assembly A10. To change the mains voltage setting proceed as follows: refer to Figure 2.1 and 2.5)

- a. Disconnect the input power cord from the receiver
- b. Disconnect the regulation transistor cable from A10J2 and remove the power supply heat sink panel by removing the four retaining screws at the rear end of the receiver side panels.

- c. Remove the eight screws positioned at the edge of the power supply rear panel A10 and withdraw the power supply assembly.
- d. Change connections on terminal strip A10A2TB1 to 110V or 220V as appropriate in accordance with Figure 2.1. The terminal strip is situated in the power supply assembly behind the rear panel.

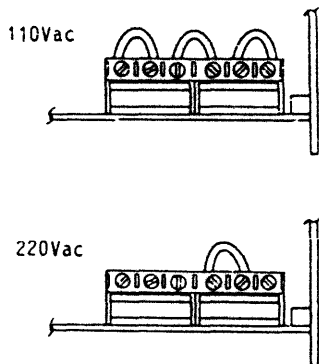

Figure 2.1
Mains Voltage Selection

- e. Reposition the power supply assembly in the receiver
- f. Reposition the power supply heat sink panel and connect the regulation transistor cable to A10J2
- g. Connect the input power cord to the receiver

The receiver is equipped with a floating inverter circuit enabling 24Vdc battery supply. If the receiver does not operate when connected to the D.C. supply, check the polarity of the D.C. (The inverter incorporates reverse polarity protection).

Both 220/110Vac and 24Vdc power sources may be connected to the receiver at the same time. When operated from two power sources the receiver automatically selects the mains power source when available. During line power drop-outs the receiver selects the 24Vdc source.

2.7 Fuses

The power source fuses depend on the supply voltage selected. Table 2.1 provides the ratings and part numbers of suitable fuses.

Table 2.1 Fuse Ratings

Fuse	Voltage	Fuse Rating	part no.
F1	110 Vac	2A Timed	262714
F1	220 Vac	1A Timed	262706
F2	24 Vdc	6.3 Timed	394629

2.8 Power Cable

In accordance with international safety standards this receiver is equipped with a three terminal power connector. When connected with an appropriate power cable the receiver cabinet should be grounded via the power connector center tap.

If the power cable is terminated with a mains plug, this should only be inserted in a socket outlet provided with a protective earth contact. The protective action must not be negated by the use of a power cable without a protective conductor (grounding).

2.9 Audio Input/Output

The audio input/output socket A10J3 (refer to Figure 2.5) provides loudspeaker output and sidetone input (later used during simplex A1A keying).

The audio input/output socket connections are as follows:

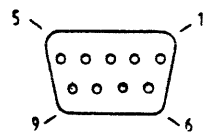

- Key
- 1 Sidetone input } 100-500 mV
 - 2 Sidetone GND } 600 ohms
 - 4-8 Loudspeaker output } 4W
 - 5-9 Loudspeaker GND } 4 ohms

Figure 2.2 Audio Input/Output Socket as Viewed on Rear Panel

The appropriate cable connector may be ordered from Marconi Marine as part of the Connector Kit, part no. 457914.

2.10 Line Output

The line output plug A7J4 (refer to Figure 2.5) provides AF line output for auxiliary equipment. The line out-

put level may be adjusted from the A7 back panel to a level between +10dBm and -20dBm/600 ohms. The line output plug connections are as follows:

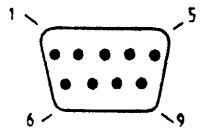

- Key
- 1 Line GND
 - 2 Line output bal.
 - 3 Line bal. center tap } -20 to +10dBm
 - 4 Line output bal. } 600 ohms

Figure 2.3 Line Output Plug as Viewed on Rear Panel

The appropriate cable connector may be ordered from Marconi Marine as part of the Connector Kit, part no. 457914

2.11 Control Input/Output

The control input/output socket A8J1 (refer to Figure 2.5) provides all digital controls to and from the receiver. The socket connections are as follows:

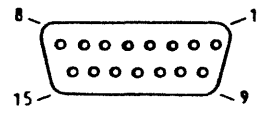

- Key
- 1 RS 232 input } Optional
 - 2 RS 323 in. GND } Optional
 - 3 Mute input (-)
 - 4 Mute input (+)

- 5 Duplex input (-) } Optional
- 6 Duplex input (+) }
- 7 Scan Stop input (-)
- 8 Scan Stop input (+)
- 9 RS 232 Output
- 10 RS 232 out.GND

Figure 2.4 Control Input/Output Socket as Viewed on Rear Panel

All control inputs are floating and exercised by 24Vdc/10mA positive logic.

The appropriate cable connector may be ordered from Marconi Marine as part of the Connector Kit, part no. 457914 .

2.12 IF Output

The receiver is equipped with a 1.4 MHz IF output socket (BNC) providing

a -20 dBm/50 ohm 2nd IF signal for auxiliary equipment. (Refer to Figure 2.5). The output signal is bandwidth filtered in accordance with the receiver bandwidth setting.

2.13 Antenna Input

The antenna input, socket A4J1 (BNC), is protected against 30Vrms/continuous and 50Vrms/15 minutes burn-out. The antenna input impedance is as stated in the relevant specifications in section 1. (Refer to Figure 2.5).

2.14 Installation Check-out

When the installation is complete refer to section 3 (OPERATION) and fully check the operation of the receiver.

SECTION 3
OPERATION

3.1 Introduction

This section of the manual contains instructions for proper operation of the Oceanic communication receiver.

3.2 Panel features

Figure 3.1 identifies and describes the functions of the front panel controls, indicators and connectors.

3.3 Power/Warm-up

The model Oceanic requires a power source of 110 or 220Vac, single phase, or 24 Vdc. The selection of power source and phases is described in Section 2, Installation.

The Oceanic power switch has two positions, OFF and ON. Power is applied to some circuits at any time the receiver is connected to the power source. If the receiver has the Oven Assembly Option installed, it is important that it remains connected to the power source to maintain a constant oven temperature, eliminating the need for a long warm-up period.

3.4 Initial conditions

After the power has been switched on, the receiver status will be as follows:

Frequency 2182 kHz
Mode AM
Bandwidth wide
AGC slow
Antenna attenuator off

NOTE

1. If the display reads OSC.FAIL, the frequency synthesis circuits are not operating properly.
2. If Ann.FAIL (nn is a two-digit number) momentarily appears in the display after turn-on, some of the initial tests indicate a failure. Refer to Section 8, Service, for failure identification.
3. If either of the above conditions occurs, refer the receiver to qualified service personnel for repair.

3.5 Self Test

The self test operation is initiated by pressing the C key, then the tune key. The self test is then carried out by the built-in microprocessor by means of a ROM-based diagnostic program package.

Press the C key again to leave the self test program.

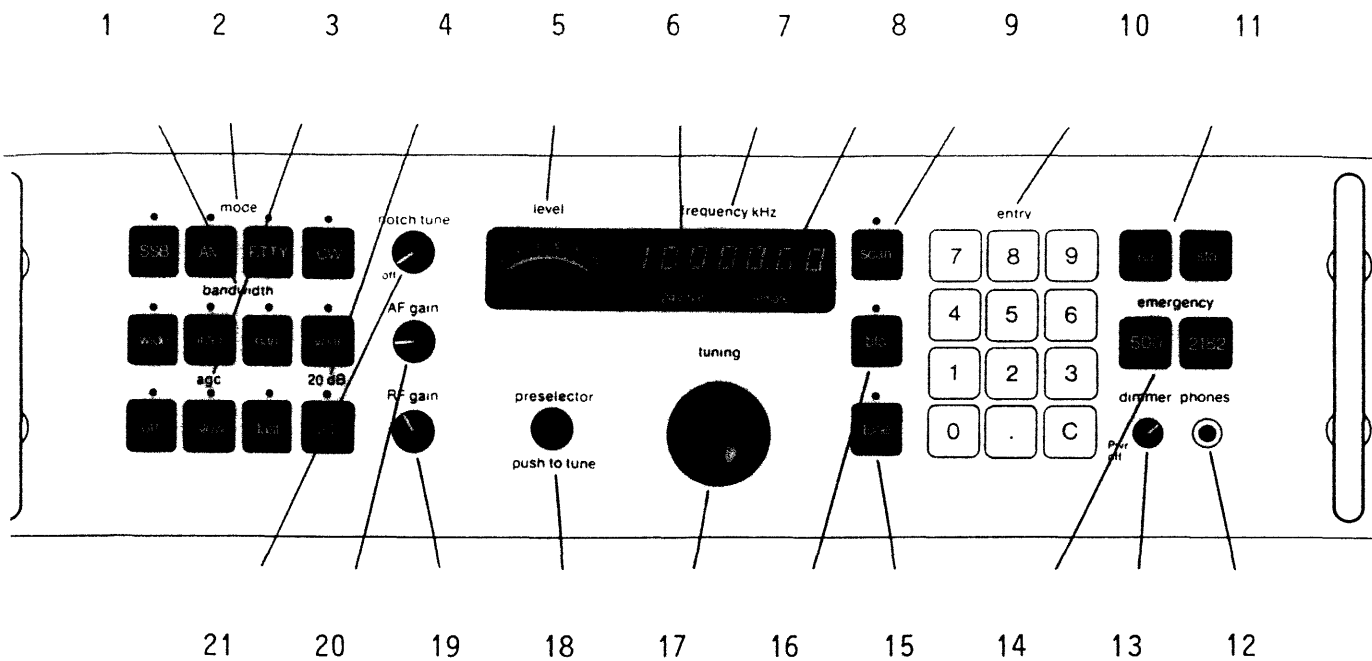

Figure 3.1 Front Panel Features

- 1 BANDWIDTH group. These keys select the IF-bandwidth when the receiver is operated in AM-or CW mode.
- 2 MODE group. These are the primary mode selection keys for reception. Pressing any mode key automatically selects default values for the secondary keys.
- 3 AGC control group. These keys select the proper AGC time constants. These constants are also affected by the MODE keys. In the "off" mode, RF-gain is manually controlled.
- 4 ATTENUATOR key. Inserts a 20 dB attenuator in the receiver front end. Used to further improve the receiver's large-signal response.
- 5 S-METER. Analog indication of the received signal strength.
- 6 POWER SOURCE annunciator. Indicates that the receiver is powered from + 24 Vdc.
- 7 ALPHANUMERIC display. Displays the receiving frequency, the BFO-frequency, error codes, and failure modes.
- 8 REMOTE annunciator. Indicates that the receiver is remotely controlled by a master.
- 9 SCAN key. Selects the automatic- and the manual scanning mode.
- 10 ENTRY group. This group includes the numeric data keys, and the clear key.
- 11 REGISTER group. These keys are used for storing and recalling user-programmed receiver settings. The recall key is also used for selection of international communication channels.

PHONES output. Connection for headphones. Disconnects the local speaker.

DIMMER/POWER control. Used for control of the light intensity in the front panel indicators. In the OFF position, power is only applied to the oven (optional) and to part of the power supply circuits.

DISTRESS keys. Used for quick-setting of the receiver on the two international distress frequencies. See paragraphs 3.7.1 and 3.9.4 for further information.

TUNE key. Enables/disables free-tuning by the control knob.

BFO key. Enables/disables the BFO control mode.

TUNING control. Used for free-tuning of the receiving frequency and the BFO-frequency.

PRESELECTOR control. Tuning control of the input filters. Pressing the preselector knob activates a built-in noise generator for easy adjustment of the filters.

RF-GAIN/SQUELCH control. Used during AGC "off" to manually adjust the intermediate frequency gain. Used in the squelch mode to control the AGC-threshold.

AF-GAIN control. Manual adjustment of the audio frequency gain.

21 NOTCH-TUNE control. Manual adjustment of an audio frequency notch filter, tunable in the range 300 Hz to 3000 Hz. Used to attenuate undesired interfering signals in the audio output.

3.6 Manual operating instructions

The following paragraphs describe the procedures for operating the Oceanic from the front panel.

They explain how to set the frequency, mode and special function controls, and covers operating instructions for standard and distress operating modes.

3.6.1 Clear display

Pressing **C** key clears the display to zero. This key is useful when an error is made while entering data.

3.6.2 Entry errors

The word "Error" will appear in the display for approximately one second when an error in programming the receiver occurs. The incorrect entry will not be accepted. Table 3.1 shows the relevant entry error-codes and their explanation.

Table 3.1 Entry errors

Error code	Message
Ø2	User register not defined
Ø3	Invalid user register
Ø4	Invalid international channel
Ø5	Invalid scan sequence
Ø6	Scan channel not defined

3.7 Quick reference operating instructions

3.7.1 500 kHz and 2,182 kHz operation

- Press **500** or **2182**
- Press PRESELECTOR and adjust for max. meter reading
- Adjust AF-GAIN for a convenient volume

3.7.2 AM operation

- Key in the desired frequency
- Press the **AM** key
- Press PRESELECTOR and adjust for max. meter reading
- Adjust AF-GAIN for convenient volume

3.7.3 SSB, CW and RTTY operation

- Key in the desired frequency
- Press **SSB** , **CW** or **RTTY**
- Press PRESELECTOR and adjust for maximum meter reading
- Adjust AF-GAIN for a convenient volume

3.8 Frequency Control

The frequency resolution can be set by the operator to 1kHz, 100 Hz or 10 Hz by pressing **.** an appropriate number of times.

3.8.1 Keyed Tuning

Key in the desired frequency by pressing numbers in sequence, just as they are written on a piece of paper.

The display immediately shows the number sequentially in right entry display format, i.e. the numbers appear in the rightmost display character and are shifted left one character on each number entry. The decimal point must be keyed if it is part of the number (unless it is to be right of the last frequency digit in kHz).

For example to key in 7501.65 kHz, simply press the following keys in sequence,

Press	Display
C	0.00
7	7.00
5	75.00
0	750.00
1	7501.00
.	7501.00
6	7501.60
5	7501.65

3.8.2 Free tuning

The tuning control is activated by pressing **tune**. A light above the key indicates the free tuning function. By rotating the tuning knob the receiving frequency is varied in quasi-continuous steps.

Pressing **tune** the second time disables the free tuning.

3.9 Function keys

The Oceanic receiver has a number of function keys that allow the operator to select operating modes.

NOTE

A lighted indicator above any key denotes it as an active entry. For example, if the "wide" key indicator is on, it is not necessary to press that key if this is the desired bandwidth.

3.9.1 Reception mode

The receiver can operate in four modes:

AM, SSB, CW and RTTY

The proper mode is selected by pressing one of the keys labelled **AM**, **SSB**, **CW**, or **RTTY**.

Pressing a mode key automatically selects standard values for secondary control keys. However, these standard settings can be altered by the operator by manual entry after the mode selection.

The following standard settings are used:

AM	- AGC (slow),	Bandwidth (wide)
SSB	- AGC (slow),	Bandwidth <disabled>
CW	- AGC (off),	Bandwidth (narr)
RTTY	- AGC (fast),	Bandwidth (Vnar)

3.9.2 AGC control

The AGC keys control the AGC time constants. Press any of the keys labelled **off**, **slow** or **fast** to select the desired mode.

In the AGC "off" mode the gain can be adjusted by means of the RF-GAIN control knob.

NOTE

The MODE keys will affect the time constants of the AGC - circuit. The AGC control keys are used for supplementary control of the AGC time constants. For further information refer to the receiver specifications.

3.9.3 Bandwidth control

The bandwidth keys **wide**, **inter**, **narr** and **vnar** select the IF bandwidth of the receiver. These keys can only be used in the AM, RTTY and CW reception modes, and will not respond to commands when the receiver is operated in SSB mode.

3.9.4 Distress keys

The two keys labelled **500** and **2182** permit quick-setting, easy-to-use reception on the two international distress frequencies. Pressing any one of these keys is accompanied by the following standard settings:

500 kHz - CW, AGC (off), Bandwidth
2182 kHz - AM, AGC (slow), Bandwidth ^(wide)
_(wide)

3.10 Storing and recalling receiver settings

The receiver contains 75 addressable storage registers that allow the operator to manually store and recall complete receiver settings.

The storage registers are part of a CMOS memory in the microcomputer and maintain their contents even though the receiver is turned off or disconnected from the power sources.

When the receiver restarts after a power failure the setting will be the same as that present before the failure occurred.

When the receiver is turned on by means of the power-switch on the front panel, it will automatically start on 2.182 kHz.

The user-programmable storage registers are indicated by the numbers .00 through .75.

3.10.1 Storing receiver settings

To store a complete receiver setting,

- Press **sto**
- Press the decimal point **.**
- Press the number keys of the applicable register address (00 through 75).

3.10.2 Recalling receiver settings

Receiver settings are recalled from storage registers in much the same way they are stored. To recall a complete receiver setting,

- Press **rcl**
- Press the decimal point **.**
- Press the number keys of the applicable register address (00 through 75)

3.10.3 Using the Rø register

The Rø register always contains the present receiver setting except for any free-tuned offset.

After a free-tuning sequence, simply press **rc1 0 0** (or **rc1 . 0 0**) to restore the original frequency setting. If, after a re-adjustment, the operator wants to update the receiver setting to reflect the current receiving frequency, he should press **sto 0 0** (or **sto . 0 0**).

3.11 Automatic channel selection

The receiver contains information on all CCIR recommended frequencies for

- Voice duplex communication in the maritime frequency bands 4, 6, 8, 12, 16 and 22 MHz.
- Telex communication in the maritime frequency bands 4, 6, 8, 12, 16 and 22 MHz.

3.11.1 Channel selection

To select an international channel,

- Press **SSB** or **RTTY** to select desired mode
- Press **rc1**
- Press the number keys of the applicable channel number

The receiver will automatically generate all settings for that particular channel.

3.11.2 International calling channels

To select an international calling channel for SSB communication

- Press **SSB**
- Press **rc1**
- Press the number of the applicable maritime frequency band (4, 6, 8, 12, 16 or 22).
- Press the decimal point **.**

The automatic channel selection function does not occupy any space in the addressable storage registers (this feature corresponds to 433 pre-programmed channels).

An attempt to select an invalid channel number will cause an "Error" condition to be flagged on the display.

3.11.3 Optional customer-defined channels

The receiver can be programmed with optional customer defined frequencies.

3.12 Automatic scanning

The receiver is equipped with an automatic scanning function that allows the operator to scan a number of selected frequencies.

Scanning can be carried out in any of the maritime frequency bands or in the user programmable storage registers.

3.12.1 Scanning international channels

To initiate a scanning sequence in one of the maritime frequency bands,

- Press **SSB** or **RTTY**
- Press **scan**
- Press the number keys of the lowest applicable channel in the sequence
- Press the number keys of the highest applicable channel in the sequence

If all channels in a frequency band are to be scanned,

- Press **SSB** or **RTTY**
- Press **scan**
- Press the number of the applicable maritime frequency band (4, 6, 8, 12, 16 or 22)
- Press the decimal point **.**

3.12.2 Scanning user-defined frequencies

To initiate a scanning sequence in the user programmable storage registers,

- Press **scan**
- Press the decimal point **.**
- Press the number keys of the lowest applicable storage register
- Press the number keys of the highest storage register

Once a scan is initiated the receiver will continue to scan from the lowest applicable channel. The display will show the settings corresponding to the current channel.

An external input signal connected to the terminal board TBI on the micro-computer subassembly A8 can be used to interrupt the scanning sequence. The standard dwell time is 9 sec.

To enter another dwell time,

- Press any of the number keys 1 through 9 to select the dwell time in seconds
- Press key 0 to select 100 msec. dwell time

3.12.3 Manual scanning

To scan a programmed sequence manually, enter a scanning sequence as described. Then

- Press **scan** again

The manual scanning mode is indicated by a blinking scan indicator.

Manual scanning is now carried out by rotating the tuning knob.

For example, to scan the SSB duplex channel in the 16 MHz band,

SSB Select SSB mode

scan

1

6 Enter scan sequence

.

scan Enter manual mode

To leave the manual mode,

- Press **scan** to reenter automatic scan

or

- Press **C** to leave scanning mode

NOTE

Only the keys labelled

scan , C , 500
and 2182 may be activated during scanning.

3.13 BFO control

The BFO-frequency is entered and displayed with 3-digit resolution. The frequency can be entered from the keyboard and/or tuned by the tuning control knob.

To enter the BFO-frequency from the keyboard,

- Press bfo
- Press 0 to select the proper sign. (+/-)
- Press the number keys of the applicable BFO-frequency, entering the decimal point in the proper place.

To adjust the BFO-frequency by the frequency tuning knob,

- Press bfo
- Adjust the BFO-frequency by means of the tuning knob

Pressing bfo the second time disables the BFO-control.

3.14 AGC Threshold control

The AGC threshold control may be activated when the receiver is operated in either of the two automatic gain control modes, i.e. "slow" and "fast".

- Press the key labelled slow or fast to select the desired AGC time constants.

- Press the active AGC key again to enter the threshold mode.

The threshold mode is indicated by a blinking AGC indicator. The AGC threshold is adjusted by turning the RF-GAIN.

To leave the threshold mode,

- Press the active AGC key.

The active AGC indicator will now light steadily.

If the threshold mode is used during scanning, the receiver will dwell only briefly, i.e. 100 ms, at channels with signal levels below the AGC threshold. If the signal level exceeds the threshold, the receiver dwells at the channel for the time selected with the keys 0-9 (see 3.12.2) and then continues scanning.

A RS232C compatible output at the rear of the receiver (A8J1) indicates in positive logic receive signals exceeding the AGC threshold. This output may be used for activation of external equipment, e.g. recording devices, selective calling detectors, audio muting circuits or the output can be looped back to the scanstop input to hold the receiver frequency as long as the input signal is above threshold.

