

WIRELESS SETS No. 19
Mark I, Mark II and Mark III

WORKING
INSTRUCTIONS

PART I

NOT TO BE PUBLISHED

The information given in this document is not to be communicated, either directly or indirectly, to the Press or to any person not holding an official position in His Majesty's Service.

For installation instructions refer to Installation Prints and other details in envelope packed with Installation Kit.

Z.A. 21575
(P.C. Ref. No. 65707)

THE CONTROL-STATION OPERATOR WHO RETURNED AFTER NETTING

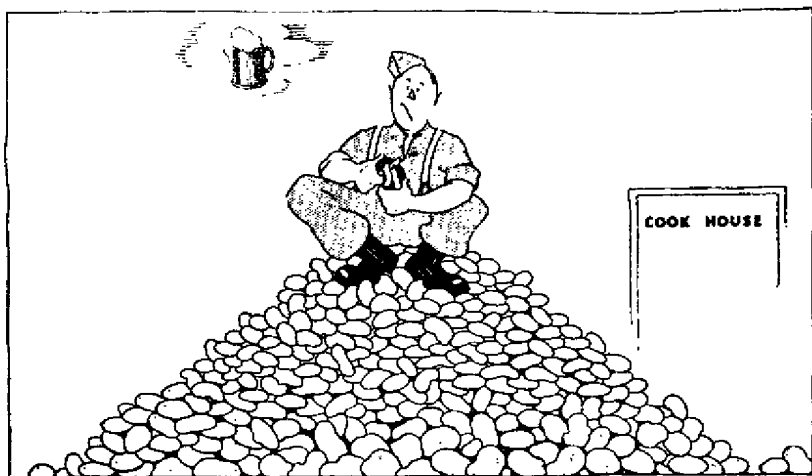

CONTENTS

CHAPTER I GENERAL DESCRIPTION

	Page
1. Purpose and facilities - - - - -	4
2. Range - - - - -	4
3. Frequency - - - - -	5
4. Power supply - - - - -	5
5. Control units and headgear - - - - -	5
6. Mark II control units for through calls and re-broadcast - - - - -	7
7. The complete installation - - - - -	8
8. What are all the knobs for? - - - - -	10
9. Improvements in Mark III - - - - -	12

CHAPTER II INSTRUCTIONS FOR OPERATING

10. Getting the set ready - - - - -	13
11. Tuning the "A" set - - - - -	14
12. Netting - - - - -	15
13. Netting in harbour with detuned aerial circuit - - - - -	15
14. Netting by wavemeter - - - - -	17
15. Netting at a distance - - - - -	17
16. Other points about the "A" set:	
1. The TRIMMER (Mk. I) - - - - -	18
2. Checking netting and re-netting - - - - -	18
3. Use of TUNE position of flick lever - - - - -	18
4. The variometer - - - - -	19
5. RT, CW and MCW - - - - -	19
6. HET. TONE control on Mk. III - - - - -	20
7. RF GAIN control on Mk. III - - - - -	20
8. What to do when in trouble - - - - -	21
17. Tuning and netting the "B" set - - - - -	21

CHAPTER III LOOKING AFTER THE SET

18. Your job and why it is important - - - - -	24
19. Connecting up and changing parts - - - - -	24
20. Daily maintenance - - - - -	29
21. Weekly maintenance - - - - -	29
22. Monthly maintenance - - - - -	33
23. Running repairs - - - - -	33
Table 1. Daily maintenance, Mark II - - - - -	34
Table 2. Daily maintenance, Mark III - - - - -	37
Table 3. Running repairs - - - - -	40

ILLUSTRATIONS

Fig.		Page
	The control-station operator who returned after netting - - - - - <i>Frontispiece</i>	
1.	Control unit no. 1 - - - - -	6
2.	Control unit no. 2, Mk. II - - - - -	7
3.	Lay-out of set in a Churchill tank - - - - -	9
4.	What are all the knobs for? - - - - -	11
5.	Rolling up the waterproof cover - - - - -	13
6.	Connecting headset-leads to drop-leads from control unit - - - - -	13
7.	Setting up a tuning dial for FLICK working - - - - -	14
8.	How to net the "A" set Mks. I & II <i>inset facing p.</i> - - - - -	16
9.	How to net the "A" set Mk. III <i>inset facing p.</i> - - - - -	17
10.	Finding the "silent point" - - - - -	16
11.	Front view of set and supply unit - - - - -	25
12.	Plugging in a connector - - - - -	24
13.	Changing an H.T. fuse - - - - -	26
14.	Changing an "A" aerial pigtail - - - - -	26
15.	Changing a fuse in control unit no. 1 - - - - -	26
16.	Taking off the grill - - - - -	26
17.	Changing valves - - - - -	27
18.	How to adjust the driver's buzzer - - - - -	28
19.	Aerial maintenance - - - - -	28
20.	"B" set aerial base - - - - -	30
21.	Weekly maintenance of set - - - - -	31
22.	Connections between vehicle and wireless equipment - - - - -	32



OH NO SARG !!! LOST THAT THREE WEEKS AGO

(See page 24.)

CHAPTER I GENERAL DESCRIPTION

I. Purpose and facilities

The Wireless Set No. 19 was designed especially for AFVs and is also now used in almost all kinds of vehicles throughout armoured formations. For this purpose it has been designed to give very clear speech so that RT conversations can be kept up in a fast moving vehicle and even through the noise of a tank.

The set gives three separate services:—

"A" set sender-receiver (long range) between different headquarters and between individual vehicles.

"B" set sender-receiver (short range) between individual vehicles in a troop or in a headquarters.

"IC" amplifier, which is a telephone intercommunication system between all members of the crew of a vehicle; this is particularly important for the tank commander so that he can speak to his gunner, driver, etc., and fight his tank. Each member of the crew has one headset and, with some exceptions, is provided with a switch to enable him to use whichever set he wishes. Both "A" and "B" sets are switched to SEND by means of the pressel switch in the microphone.

The "A" set has facilities for RT, CW and MCW. The "B" set has facilities for RT only. The "A" and "B" sets each have a separate rod aerial.

The No. 19 set comprises in each case a complete installation for a particular vehicle; the connectors, etc., are of special lengths and types to fit that vehicle and may not fit a different one without a great deal of difficulty. It is fitted in a tank by the manufacturers, but is otherwise delivered in three boxes, one of which holds the installation kit for the kind of vehicle marked on the outside.

2. Range

I. **"A" set.** The ranges obtainable depend on many variable factors such as the intervening country, frequency, time of day, etc. Approximate ranges obtainable on the move with an 8' rod during daylight over average country in the British Isles are:—

RT and MCW	..	10 miles
CW	15 miles

Greater ranges can be obtained when conditions are good and by using longer aerials.

2. **"B" set.** 20" rod aerial (not adjustable). Up to 1 mile in open country, but reduced to about 300 yards by buildings, hills, woods, etc.

3. Frequency

1. "A" set.

Mk. I. 2.5 to 6.25 Mc/s.

Mks. II and III. 2.0 to 8.0 Mc/s in two switched bands.

It can therefore work to Wireless Sets Nos. 9, 11, 18, 21, 22 and 38.

2. **"B" set.** 235 Mc/s, variable only a very little.

4. Power supply

The power supply unit is in a separate case mounted in the same resilient cradle as the set and is designed to work from a 12-volt accumulator. It consists in Mks. I and II of a single rotary transformer with two H.T. windings (275 and 500 volts) and in Mk. III of two rotary transformers, one of which runs all the time and the other starts up by relay action when the "A" set is switched to SEND. The Mk. III type takes much less current to run it.

The supply is normally taken from 170 AH wireless batteries or the vehicle battery (150 AH in most British tanks).

BATTERY CONSUMPTION

Conditions on RT.	Battery drain (amps.).		Approx. hours working with 150 AH battery.	
	Mks. I & II.	Mk. III.	Mks. I & II.	Mk. III.
"A" set receive, "B" and "IC" off ..	8.0	4.6	14	24½
"A" set receive, "B" receive, "IC" off	9.4	6.4	12	17½
"A" set receive, "B" receive, "IC" on	10.0	7.1	11	16
"A" set send, "B" send, "IC" on ..	11.6	10.7	10	10½
All on, 25% on send	10.4	8.0	11	14

5. Control units and headgear

Each member of the crew has a headset (headphones and microphone combined) which is connected by a "drop-lead" and "snatch-plug" to a "control unit" within easy reach. On the control unit there is a selector switch to enable the user to speak or listen on "A" set, "B" set or "IC."

In an AFV the commander and operator can switch to all three, but the gunner, driver and co-driver remain on "IC." Everyone

CONTROL UNIT No. 1

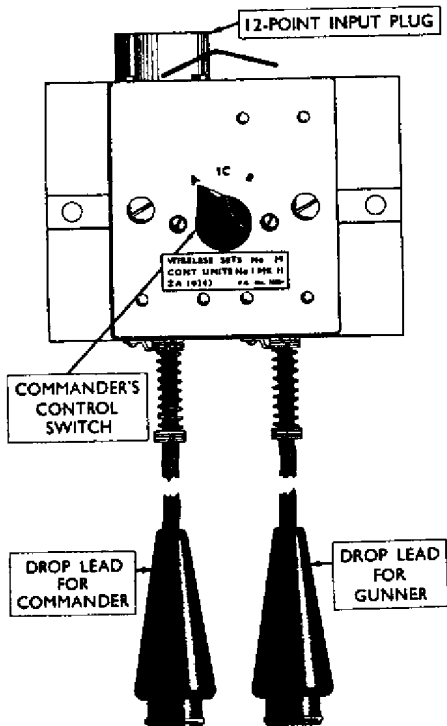

Fig 1. in the turret has a "head-gear assembly no. 1" connected to a control unit. The driver and co-driver in the tank will often have a "headgear assembly no. 2," which has the same headphones but a larger and heavier microphone, and is connected to a "junction distribution" which looks like a control unit without a switch. The driver has a press button operating a buzzer instead of a switch, so that he can attract the attention of the commander if he is speaking on the "A" or "B" set. The two types of headgear are not interchangeable.

There are several different kinds of control units and junctions distribution. Below is a table showing the switching arrangements of the most important ones.

CONTROL UNITS

Type number.	Drop leads for	Remarks.
No. 1.	Commander Gunner (right hand)	Switched "A," "IC," "B." "IC" only.
No. 1A.	Commander Gunner	Both switched together from one switch ("A," "IC," "B").
No. 2, Mk. I.	Operator	Switched "A," "IC," "B." Red lamp lights when "A" set unattended.
No. 2, Mk. II.	Operator	Switch for "A," "IC," "B." Switch for "Re-broadcast." Red warning lamp as Mk. I.
No. 3.	Commander Operator	Switched "A," "IC," "B." } each with " " " " } own switch.

JUNCTIONS DISTRIBUTION

Type.	Drop lead for	Remarks.
No. 1.	Driver	{ Push button for buzzer. Headgear no. 2.
No. 2.	Co-driver	{ No buzzer. Headgear no. 2.
No. 3.	Driver and co-driver or 2 additional crew	{ Push button for buzzer. Headgear no. 1.

6. Mark II control units for through calls and re-broadcast

1. Operator's control units Mk. II are fitted with two switches, one having two positions marked "N" and "R," signifying "Normal" and "Re-broadcast." Position "N" allows the other switch to be used exactly as the switch on the commander's control unit, selecting for the operator's use either "A," "IC" or "B." Position "R" has two uses: firstly for connection of "through calls" and secondly for "re-broadcast."

2. Through calls enable a distant station on the "A" net to communicate directly with a distant station on the "B" net, the control unit acting in the same way as a telephone exchange, except that the second switch must be moved each time the direction of communication changes. To achieve this, messages spoken by the distant station on the "A" net are re-transmitted on the "B" net (A→B) and replies spoken by the distant station on the "B" net are re-transmitted on the "A" net (B→A).

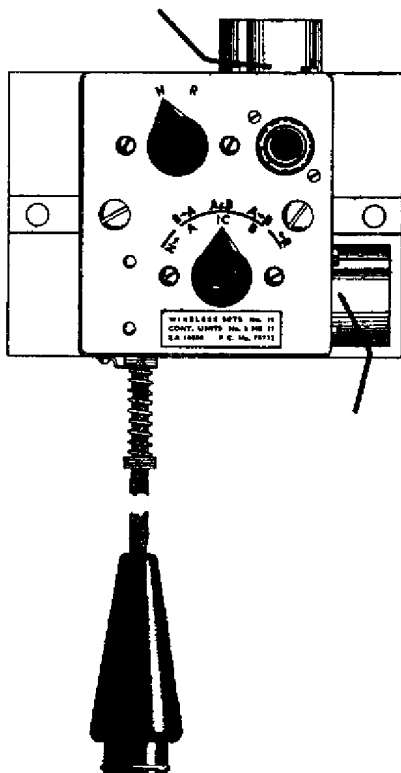

CONTROL UNIT No. 2, Mk. II Fig. 2
re-transmitted on the "A" net

3. The second switch must be moved from "A→B" to "B→A" or vice versa whenever the word "over" is said by either station. The "A and B" position allows the commander or the operator to join in, transmission taking place on both nets at once.

4. While through calls are connected, the commander can listen but cannot transmit on either "A" or "B" set without interrupting the through conversation, but he can use "IC" in the ordinary way to converse to any of his crew except the operator.

5. Re-broadcast is the permanent or temporary relaying of all signals on the "A" net of one vehicle at a headquarters to the "B" sets of all the other vehicles at that headquarters, so that they may hear all that is said on that net. The "B" net cannot be used for other purposes while re-broadcast is taking place. All that is necessary is for the operator to set his switches to "R" and "A→B." The commander's switch should be set to "A" and his speech will not only be heard on the "A" net, but also re-broadcast on the "B" net.

7. The complete installation

The CHURCHILL tank has been chosen as a good example of how the set is installed and used. Other AFV installations differ in detail, but the idea is the same. Fig. 3 is a drawing of the inside of the turret showing the lay-out.

The set, with power supply unit beside it, is housed in the bulge at the back of the turret. It has a protecting grill over the front of it, which still allows you to reach the controls. A waterproof cover keeps the control panel dry when the set is not in use. Power for the set is taken from the vehicle battery through the slip rings of the "rotary base junction" and the 5-way terminal block to the supply unit.

The "A" aerial is of the fishing rod type, maximum height on the move 12' in 3 sections, and it is mounted on a flexible rubber base on the outside of the turret. It is connected to the set through the variometer mounted inside the turret immediately below the aerial base.

The "B" aerial is a 20" rod also mounted on the turret and is connected by a feeder direct to the set.

In the turret of this tank are the commander, his loader-operator, and the gunner, and forward in the hull the driver and co-driver; all five wear headsets. The commander's and gunner's headset connections come from a control unit no. 1 on the near side of the turret; by turning the switch the commander can speak or listen on "A," "IC" or "B," but this switching does not affect

LAYOUT OF SET IN A CHURCHILL TANK

Fig. 3

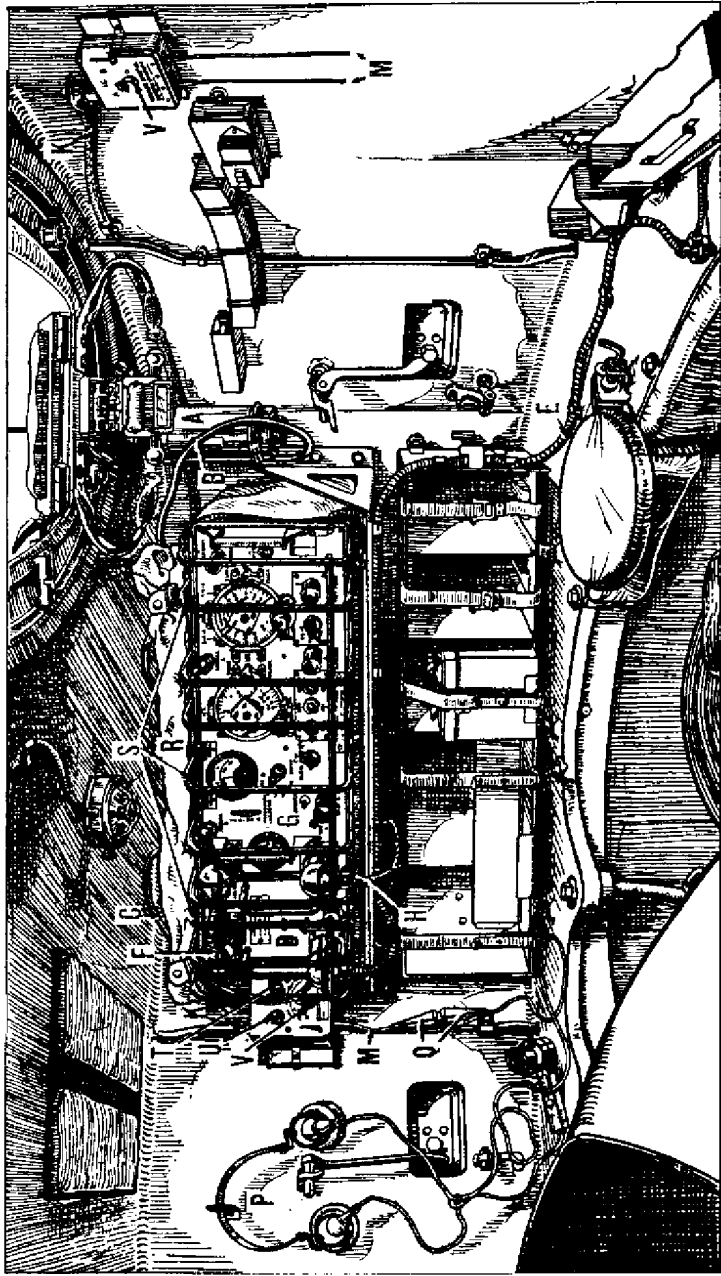

- A. Variometer.
- B. Lead from variometer to set.
- C. Lead from "B" aerial to set.
- D. Power unit.
- E. Leads from batteries to power unit.
- F. 12-point connector from power unit to set.
- G. Set.
- H. 12-point connector from set to operator's control unit.
- I. Control unit no. 2 Mk. II for operator.
- J. 12-point connector from operator's control unit to commander's control unit.
- L. Control unit no. 1 Mk. II for commander and gunner.
- M. Drop leads.
- P. Headset no. 1 complete.
- Q. Snatch plug and socket.
- R. Waterproof cover.
- S. Grills.
- T. Pilot light.
- U. Re-broadcast switch.
- V. "A" "C" "18" switch.

the gunner, who remains all the time connected to "IC." The loader-operator is connected to a control unit no. 2 on the off side of the turret and can switch to "A," "IC" or "B." Both these control units are connected to the set through 12-point connectors.

Communication from the commander to the driver and co-driver in the hull has to pass through the slip-ring of the rotary base junction. The driver has a junction distribution no. 1 with a push-button and the co-driver a junction distribution no. 2 without a push-button.

The commander and loader-operator normally have their switches to "IC." A signal arriving on either the "A" or "B" set will be heard on the "IC" system. As soon as this occurs the operator will switch to the set on which the signal appears, say "B" set. This will remove the signal from the "IC" and transfer it to the operator's headset only, which is now also disconnected from the "IC" system. While the operator is speaking on or listening to the "B" set, a further signal may be heard on the "IC" system. This must be arriving on the "A" set.

The commander then switches his box to "A," thus disconnecting himself and the incoming signal from the "IC" system. The two forward members of the crew are now isolated from the commander, but in an emergency the driver can call the commander's attention by pressing the button on his box. The commander will then break off his conversation on the set that he is using and switch to "IC." The driver, co-driver and gunner are all permanently connected to "IC" and are unaffected by the position of the switches on the control units.

8. What are all the knobs for?

This is really the loader-operator's business, but the commander and gunner, and even the driver, should know something about it as well. Before *anything* will work, you must switch the power on; the switch for this is on the supply unit. Whenever you are speaking into the microphone on either "A," "B" or "IC," press the pressel switch on the microphone handle and let it go when you have finished. When you are speaking on "A" or "B," pressing this switch changes the set from RECEIVE to SEND. Hold the rubber mouthpiece very close to your mouth and speak as loudly as you can without shouting.

The diagram (Fig. 4) gives you all the information you need about the knobs in a nutshell, and it is worth while having a good look at it with the set in front of you; here are a few hints to help you to use the controls correctly.

WHAT ARE ALL THE KNOBS FOR?

W.S. No. 19 Mk. III

Fig. 4

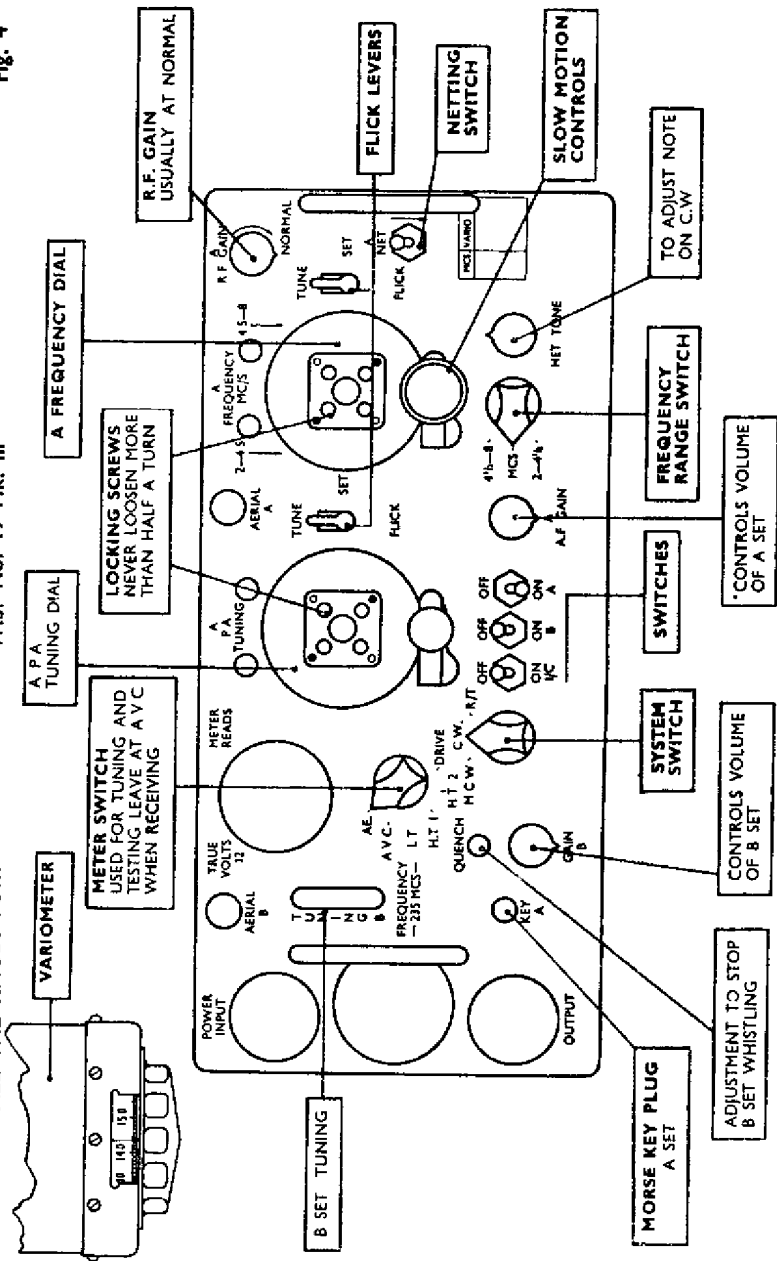

First of all the "IC"; this will always be working so long as the set is switched on and the A ONLY—ALL switch is at ALL on Mk. I and II, or the ON—OFF IC is ON on Mk. III. There's no volume control on the "IC," so if you can't hear the driver you must just tell him to "speak up" as you would on an ordinary telephone. You must remember that the commander and loader-operator can't talk on the "IC" unless their control switches are turned to "IC," and don't forget to press the pressel switch when you are talking and to let it go when you are listening. Second, the "A" set. Once you have netted up (all about netting a little later) you need only the A GAIN control to make this set louder. Lastly, the "B" set; once the net is set up you should only have to use the B GAIN control to make the signal louder or softer.

Just a last general word about the knobs. The knobs will turn so far and no further. Do not try to strain them beyond this point or you will damage them.

9. Improvements in Mark III

1. There are a number of improvements incorporated in the Mk. III, chief of which are less drain on the batteries and improved working on CW.

2. **The supply unit** includes two separate small rotary transformers (see sect. 4), instead of one large one.

3. **Switches.** Instead of the A ONLY—ALL and OFF—ON B switches, there are now three switches OFF—ON A, OFF—ON B, OFF—ON IC. These enable any one or more of the three systems to be used as required without wasting current on any not wanted at the moment.

Since the valves in the "A" set will not heat up until OFF—ON A switch is ON, this should be done 15 minutes before the "A" set is required for use to allow time for it to settle down.

Similarly, if the "B" set or "IC" is wanted it should be switched on a minute or two beforehand. If, however, either "B" or "IC" is already on, the other is ready for use immediately its switch is put on: this is because the "B" and "IC" valve heaters are connected up together.

4. **Netting switch.** Instead of the netting button, there is a toggle switch. This enables the operator to check his net with one hand. Up is normal; down is for netting.

5. **Slow-motion tuning control.** To make tuning easier, the A FREQUENCY tuning control is now fitted with a two-speed slow motion knob. The larger of the two concentric knobs gives the same speed as on Mk. II, while the smaller knob gives a further reduction for accurate tuning.

6. **HET. TONE control.** This now gives a wider range of note with zero in the centre. A filter is incorporated which makes a note of 1000 cycles per second stand out much louder than any others. See para. 16, 6.

7. **RF GAIN control.** This is not fitted at all on Mks. I and II. Except for netting it is nearly always left at NORMAL (maximum clockwise) and must *never* be used as a volume control. See para. 16, 7.

CHAPTER II

INSTRUCTIONS FOR OPERATING

10. Getting the set ready

(In a tank this will usually be done as part of the tank "First parade.")

1. Erect "A" and "B" aerials.
2. Roll up the waterproof cover and stow at top of set (see Fig. 5).
3. Connect all headsets to correct drop leads (see Fig. 6).

ROLLING UP THE WATERPROOF COVER

Fig. 5

1. Lift up cover.
2. Roll up tightly.
3. Fasten press-studs.

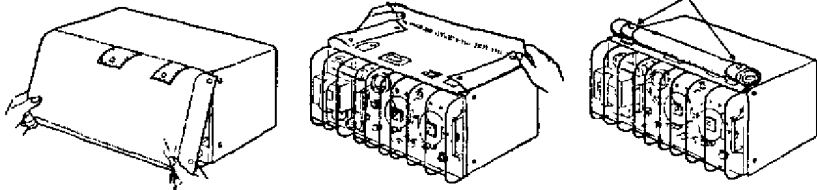

CONNECTING HEAD-SET LEADS TO DROP LEADS FROM CONTROL UNIT

Fig. 6

2. Moisten brass ring before plugging in again

1. Undoing

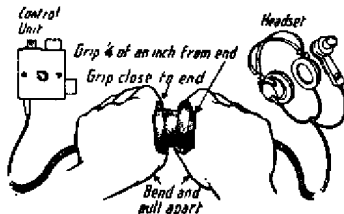

3. Plugging in



4. Mks. I and II. Put A ONLY—ALL switch to ALL.
Mk. III. Put A OFF—ON switch to ON.
5. Put switch on supply unit to ON.
6. Do the tests described under daily maintenance, Chapter III, to see that everything is in working order.

II. Tuning the "A" Set

Before you can net your set in a group you must learn to tune it to the required frequency and to use the "flick" controls

Your group may be given two frequencies to work on, the "blue" or normal and the "red" or spare frequency. The flick tuning allows you to tune the set for working on either and to change quickly from one to the other. You will notice beside each of the main tuning controls a small lever with three positions, TUNE, SET and FLICK. Fig. 7 shows how to set up a tuning dial for two flick frequencies. When this flick lever is turned to TUNE, the fine tuning knob will turn the tuning dial to any frequency as in a broadcast receiver, and if flick frequencies are not in use the set may be tuned in this way. Figs. 8 and 9 show exactly how to tune the "A" set.

SETTING UP A TUNING DIAL FOR FLICK WORKING

Fig. 7

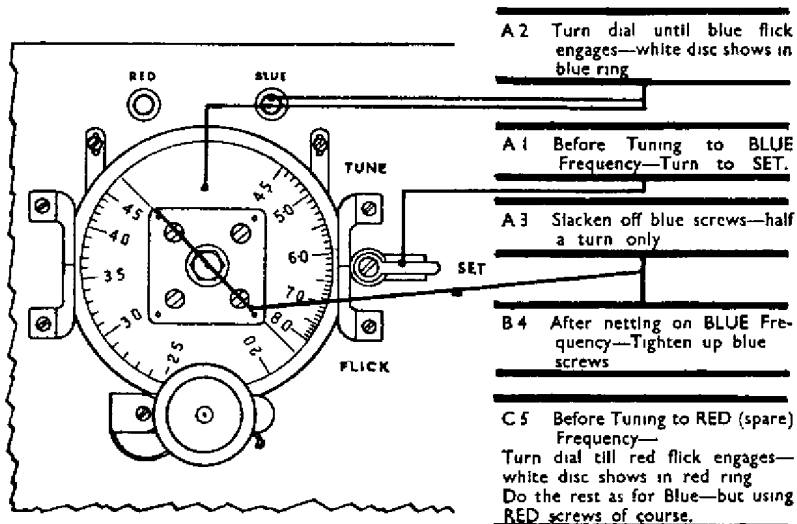

PREPARE SET FOR NETTING

Mks. I & II

- 1 Set to AVC
- 2 Set to RT
- 3 Fully clockwise
- 4 MK II Set to correct range
- 5 Both levers to FLICK
- 6 Turn until WHITE shows in blue windows
- 7 Hold dials and loosen BLUE screws
- 8 Turn to ordered frequency
- 9 Both levers to SET
- 10 Turn until rustling noise in phones is loudest

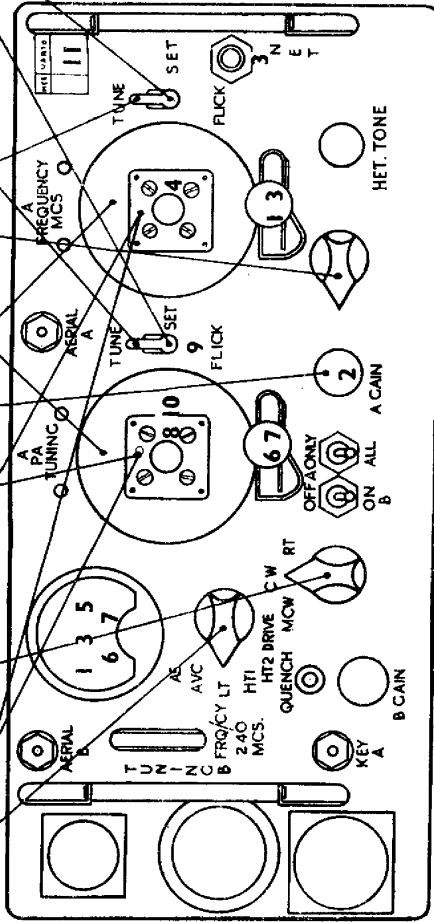

NETTING IN HARBOUR

NETTING DRILL

Use the numbers here for NETTING BY NUMBERS when training

- 1 Search boldly for control, choose signal giving max. dip on A.V.C.
- 2 Reduce A GAIN to give strength of 2 signal
- 3 Press NET, tune A FREQUENCY dial to zero beat and max. dip
- 4 Lock correct screws of A FREQUENCY dial
- 5 Adjust VARIOMETER for max. dip on AVC. See para 16, 4. Warning
- 6 Adjust A PA TUNING for max. dip on AVC
- 7 Readjust VARIOMETER and A PA for max. dip
- 8 Lock A PA TUNING screws
- 9 Turn A PA TUNING to FLICK
- 10 Turn A PA TUNING away at least one MC/S
- 11 Note VARIOMETER reading on tablet and in log



Fig. 3

PREPARE SET FOR NETTING

Mk. III

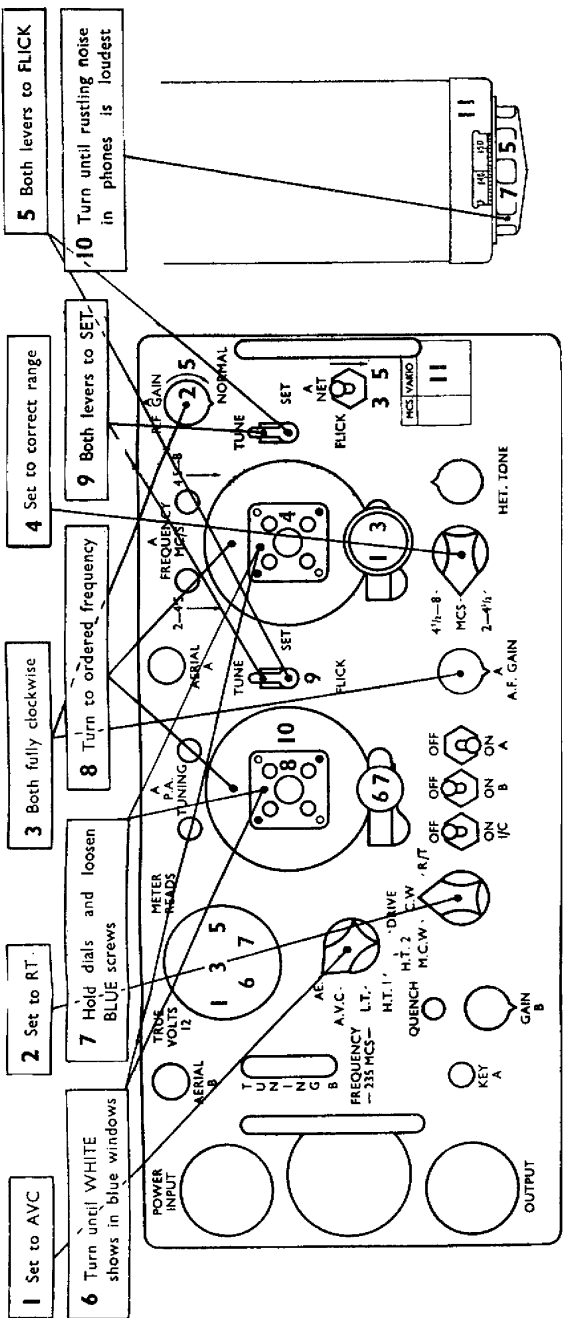

- 1 Set to AVC
- 2 Set to RT.
- 3 Both fully clockwise
- 4 Set to correct range
- 5 Both levers to FLICK
- 6 Turn until WHITE shows in blue windows
- 7 Hold dials and loosen BLUE screws
- 8 Turn to ordered frequency
- 9 Both levers to SET
- 10 Turn until rustling noise in phones is loudest

NETTING IN HARBOUR

NETTING DRILL

Use the numbers here for NETTING BY NUMBERS when training

- 1 Search boldly for control, choose signal giving max. dip on A.V.C.
- 2 Reduce R.F. GAIN to give strength 2 signal
- 3 Switch to NET, tune A FREQUENCY dial to give zero beat and max. dip
- 4 Lock correct screws of A FREQUENCY dial
- 5 NET switch up R.F. GAIN to NORMAL, Adjust VARIOMETER for max. dip on AVC METER. See para 16, +. Warning
- 6 Adjust A PA TUNING for max. dip on AVC
- 7 Readjust VARIOMETER and A PA for max. dip
- 8 Lock A PA TUNING screws
- 9 Turn A PA TUNING to FLICK
- 10 Turn A PA TUNING away at least one MC/S
- 11 Note VARIOMETER reading on tablet and in log



Fig. 9

12. Netting

1. It doesn't matter how good the wireless set you are using may be, you will not have good signals on a group of stations unless they are all accurately tuned to the same frequency. Bringing a group of stations on to the same frequency is called "netting," and to do it successfully all the operators in the group must know exactly how to tune the wireless set quickly and with confidence. This has been described in the last section. They must also understand and carry out the netting drill accurately, remembering that the control station is always right and his instructions must always be obeyed immediately.

2. Netting is always done before a force goes into action. The enemy must not hear you netting if it can be helped, since if he does, he will know your frequency and listen to your instructions, or jam them. Also he may find out roughly where you are by direction finding.

3. Netting is done in three ways:—

(a) Netting vehicle stations in harbour with sender's aerial circuits detuned to reduce range.

Used whenever it is possible, since the enemy is not likely to hear you.

(b) Netting by wavemeter.

Used when it is not possible to bring all the sets together and it is vital that the enemy should not hear the netting. Also used by control station whenever a wavemeter is available.

(c) Netting at a distance.

Used when (a) and (b) are impossible.

4. Before opening up you will have been told the frequency or frequencies and code signs for the group, the time at which the netting is to begin, and the details of the netting signals. Switch your set on fifteen minutes before netting is due to start, because the set takes a quarter of an hour to settle down, and spend the time making the tests for daily maintenance.

13. Netting in harbour with detuned aerial circuit

1. **Detuning the aerial circuit** means adjusting it so that signals are too weak to be heard far from harbour. Use the same length of aerial as you will use out of harbour. Make sure you are detuned before sending; the A PA TUNING dial should be turned away at least 1 Mc/s for this purpose.

2. *Tuning the control station's set.*

(a) *With a wavemeter.* Always use one whenever possible as it gets you on to the exact frequency and so avoids interference with other groups.

- (i) Net the set by wavemeter as described in section 14.
- (ii) Switch to MCW and half insert key plug.

(b) *Without a wavemeter.*

- (i) Prepare set for netting (see Fig. 8 or 9) on BLUE frequency, setting frequency as accurately as possible. The electrician signals will give you details of the errors in your FREQUENCY dial calibration.
- (ii) Do 4 of netting drill (see Fig. 8 or 9).
- (iii) Repeat (i) and (ii) for RED frequency if used.
- (iv) Turn A PA TUNING dial away at least 1 Mc/s from BLUE frequency (lower if possible) and A FREQUENCY dial to BLUE setting.
- (v) Switch to receive and half-insert key plug.

Note:—After setting up as above, control station must on no account alter his A FREQUENCY dial setting (see Frontispiece).

FINDING THE SILENT POINT (ZERO BEAT)

Fig. 10

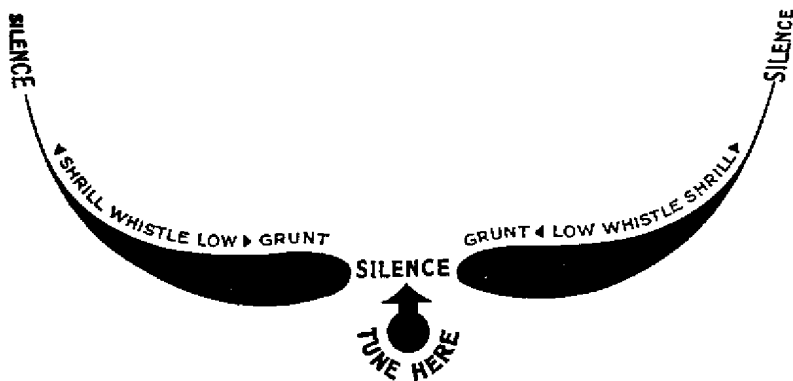

3. *Netting the Group.*

(a) Before netting time, control station will tune as above and outstations will prepare set for netting.

(b) At the time ordered for netting, control will push home his key plug and send tuning call (a morse letter) for a short period. If netting by numbers, continue until order 3 (see Fig. 8 or 9).

(c) Stop keying but leave the key plug home (thus sending out a plain carrier wave) until outstations have had time to net, or if netting by numbers till order 10. Then send tuning letter once and pull plug half out.

(d) Switch to RT and make a check call.

(e) While outstations answer in turn, control listens carefully with button pressed to NET (Mks. I and II) or netting switch down (Mk. III). Control should hear clear answers with no whistles or only a very low pitched note. If any reply is badly distorted or gives a high pitched whistle, the outstation is off net and should be ordered to re-net, (b) and (c) being done again.

(f) If control has not used a wavemeter he has still to set his A PA TUNING dial and variometer. This he must do by telling an outstation to send a carrier (by pressing pressel switch) and then setting A PA TUNING and doing numbers 5 to 11 of the netting drill.

(g) If the group has an alternative frequency, the netting is repeated for this frequency with flicks set to RED.

14. Netting by wavemeter

All sets are netted alike, as below:—

(a) Prepare set for netting (see Fig. 8 or 9) on BLUE frequency before wavemeter arrives.

(b) The wavemeter should be brought near to your aerial and will be sending a very weak CW signal.

(c) Do netting drill as Fig. 8 or 9, but press NET button (Mks. I and II) or turn down NET switch (Mk. III) for numbers 1 and 2 as well.

(d) If the group has been given a spare frequency, the wavemeter should now be set to this frequency and you will net on it with the RED flicks engaged (see Fig. 8 or 9).

15. Netting at a distance

1. Tuning control station set.

(a) *With a wavemeter.*

(i) Net set by wavemeter as above.

(ii) Switch meter to AE and do 5 to 9 and 11 in the netting drill (see Fig. 8 or 9), but for maximum reading on the meter with the set on SEND.

(iii) Repeat (i) and (ii) for RED frequency if required.

(iv) Switch to MCW and half insert key plug.

(b) *Without a wavemeter.*

- (i) Prepare set for netting (see Fig. 8 or 9) on BLUE frequency, setting A FREQUENCY dial as accurately as possible. The electrician signals will give you details of the errors in your dial calibration.
- (ii) Do 4 of netting drill and 5 to 9 and 11 for maximum AE reading on SEND.
- (iii) Repeat (i) and (ii) for RED frequency if required.
- (iv) Switch to MCW and half insert key plug.

2. **Netting the Group.**

As in harbour, but ignore 10 of the netting drill (see Fig. 8 or 9), i.e., leave A PA TUNING in correct position.

Outstations will switch meter to AE and make fine adjustment to variometer while answering the check call to get maximum meter reading.

STANDARD TIMES FOR NETTING SIGNALS

	<i>In Harbour.</i>	<i>Out of Harbour.</i>
Tuning call	½ minute	1 minute
Netting call	½	½ "
Pause before check call ..	Nil	½ "

16. **Other points about using the "A" set**

1. **The TRIMMER** (Mk. I only). The line on the TRIMMER dial must always be set to the line on the panel, and the dial clamped.

2. **Checking your netting and re-netting.** For various reasons, such as the heat of the day or the state of your battery, the frequency of your set will vary slightly and this will put you off net. A good operator knows immediately he is tending to go off net by a rise in the pitch of control's voice, which also becomes slightly distorted, and rise in pitch of the background hiss. Bad quality usually means bad netting. You must correct this; so wait till you hear control sending to another station, and press your NET button or switch. You should hear nothing, or a low note; if you hear a whistle it means that you are going off net and you must re-net. This is done exactly as in "Netting at a distance" (section 15), but control *must* be sending all the time you are doing it.

3. **Use of the TUNE position of flick lever.** If your set goes off net very frequently, when checking net set the flick levers to TUNE. You can now adjust both dials with the fine adjuster without loosening the flick screws each time. But remember that if you turn back to FLICK or SET, the mechanism will pull your tuning dial back to its old setting, thus undoing all

your correction. The first opportunity should be taken to re-set the flick device, but this should *not* be attempted unless you are stationary and control is making a long transmission to another station on the group of no interest to you. Having re-set the flick, the levers should be left at FLICK until the set is next noticed going off frequency.

4. **The variometer.** This needs readjusting whenever the frequency of the set or the length of the aerial is altered. When you set up for flick working, note the variometer settings for the two frequencies on the writing tablet at the right-hand end of the set and in your log so that you can re-set the variometer quickly when changing frequency. There are two scales on the variometer 0—100 and 200—100. The lower frequencies will have a setting on the lower scale (0—100), the lowest frequency near 10; high frequencies will have a setting on the higher scale (200—100), the highest near 110.

Warning. The positions where you change from one scale to another are marked by red bands. Never use a setting covered by either of these bands if you can avoid it. If you find a setting on or a little below either red band, say between 80 and 100 or between 180 and 200, always see if you can get better results at the top of the other range; for example, if you get a reading of 8 volts on meter at 92 on variometer scale you may find you can get 9 volts on meter at about 187.

If there are two positions, choose the one which gives the greater dip at AVC or greater radiation on AE on the meter, unless it is on a red band of the variometer.

5. **RT, CW and MCW.**

(a) The set can be used for three kinds of working:—

RT—meaning radio telephony.

CW—meaning continuous wave.

MCW—meaning modulated continuous wave.

CW and MCW are two kinds of morse working. On CW, pressing the morse key sends out a signal which can only be heard when the receiving station is switched to CW. On MCW, pressing the key has the same effect as whistling into the microphone when working RT; that is to say, a signal is sent out which can be heard even if the receiving station is switched to RT.

(b) Advantages of MCW are:

- (i) If there is interference on your frequency from other groups using CW you may get less interference if you use MCW.
- (ii) You can hear your own morse signals in the phones. (On CW you only hear clicks.)

(c) Advantages of CW are:

(i) You get greater range.

(ii) If there is interference on your frequency from other groups using RT or MCW, you may get less interference if you use CW.

(d) SEND-RECEIVE switching.

On speech, the pressel switch does this (see section 8).

On morse, the key-plug must be plugged fully into the set while sending. When receiving it must be pulled half out.

6. **HET. TONE control on Mk. III.**

This is used only when receiving CW. Check that zero or a very low beat note is obtained when the pointer is at the centre index mark. If it isn't, check your net. Then turn the control until the loudest note is obtained. It does not matter which way you turn it, but if you are getting interference from another station on one side, try the other side and you may lose the interference.

7. **RF GAIN control on Mk. III.**

This is not fitted at all on Mks. I and II. It should nearly *always* be at maximum clockwise (marked NORMAL) and *never* used as a volume control (use AF GAIN for this). It may be used only in the following circumstances:—

(a) *To receive a strong CW signal.* A very strong CW signal will swamp certain parts of the receiver and result in only a weak note being heard. In this case, turn down RF GAIN slightly and the signal will get louder; if you turn it down too much the signal will get weaker again. It may also be necessary to make a slight readjustment to the HET. TONE control to keep the signal at the loudest pitch.

Of course if the CW signal is weak because the sender is nearly out of range, reducing the RF GAIN will only make matters worse.

(b) *To reduce background noise.* If you are maintaining a listening watch in conditions where the background noise is very bad due to atmospheric, you can listen with less fatigue if you reduce the RF GAIN a little, but do not reduce much or you will miss signals you want to hear.

(c) *To reduce interference.* If you are trying to hear a fairly weak signal which is being interfered with by a strong signal on a nearby frequency, you can sometimes hear your station better by turning down the RF GAIN a little. The best setting is critical and this procedure is not always effective.

8. **While working, if signals become worse and worse,** or fail altogether, keep calm. You can't do much but you *can*:

(a) Check the netting. If your set is going off net, re-net it on the control station (see section 15).

(b) Check your "ends"—batteries, headset and aerial and their connections. Check the meter reading on AE. Is there sidetone?

(c) Call a nearer station to prove your own set O.K.

(d) If still no answer, put up another aerial section and call again. Remember the variometer, para. 16, 4.

(e) If this fails, call control on MCW; *don't* try CW unless ordered to do so.

(f) Failing this, move your vehicle; trees, power lines, houses, etc., may be screening you.

(g) If on FLICK, turn A FREQUENCY flick lever to TUNE. If on TUNE already, make a pencil mark on the right hand tuning dial so that you can bring it back to *exactly* the same setting. Search up to one division (100 Kc/s) either side of this pencil mark to see if you can pick up control station. *Return* to FLICK or to the pencil mark for calling him if you do not find him when searching.

(h) If all this fails, your set may be at fault, in which case turn to **Running repairs**, section 23. This will tell you what may be wrong and how to put it right.

17. Tuning and netting the "B" Set

1. It is best to net at approximately working distances. Before starting you should know the tuning disc setting ordered, the code signs of the stations on the group, when netting will begin and the tuning call. Just before this time all stations:—

2. **Prepare "B" set for netting.**

(a) Mks. I and II only. Put the A ONLY—ALL switch to ALL.

(b) Put the OFF—ON B switch to ON.

(c) Turn switch on control unit to "B."

(d) Turn the knob GAIN B clockwise as far as it will go.

(e) Turn B TUNING disc to ordered setting (normally 5).

(f) Control station is now set up ready to send.

3. **Netting the group.**

(a) Control station presses his pressel switch and sends a tuning call, which is a plain language word as ordered, for about 15 seconds, ending with "Tuning call ends."

(b) Outstations.

- (i) Search with B TUNING disc for the tuning call.
- (ii) Turn down GAIN B to strength 3 signal.
- (iii) Adjust B TUNING disc to *clearest* possible signal.
- (iv) Turn up GAIN B when they hear control say "Tuning call ends."

(c) Control makes a check call and outstations answer in turn in the usual way. If control cannot hear an outstation clearly, he should adjust his disc up or down to the point of *clearest* reception. He then returns to the ordered setting and tells the outstation to make a slight adjustment up or down accordingly, e.g., "move down 2," and makes another check call.

4. **QUENCH adjustment.**

(a) The QUENCH adjuster should *never* be touched except on orders from control.

(b) If there is a loud whistle caused by the interaction of "B" sets on a group:—

- (i) Control, *after* netting, orders all outstations to screw quench adjuster right in. Control screws in his own adjuster, and there is a change in the pitch of the whistle or whistles.
- (ii) If the whistle is still loud when all adjusters are screwed in, control orders all outstations except the first to put OFF—ON B switch to OFF.
- (iii) If there is still a whistle (i.e. between control and the station with "B" set left switched on), control tells that station to screw his adjuster out again and listens.
- (iv) Outstation screws adjuster out until pitch of whistle is too *high* to be heard, and then tells control "O.K." If control is not satisfied he tells the outstation to readjust.
- (v) With the first outstation still switched on, control by some means (e.g. a visual signal) tells the second outstation to switch on his "B" set.
- (vi) If there is again a whistle (i.e. between control, the first outstation and the station newly switched on), control tells the station newly switched on to screw his adjuster out.
- (vii) The outstation newly switched on screws adjuster out until the pitch of the loudest whistle is too high to be heard, and then tells control "O.K."
- (viii) Same drill for remaining outstations, one being added to the group at a time. It is sometimes appropriate, e.g. on the move, to switch the "B" sets on at intervals

of 30 secs. The more stations there are on a "B" set group the less likely is it that the weaker whistles can be tuned right out, but these whistles do not seriously interfere with communication. When all stations on a "B" set group have adjusted QUENCH, it should not be necessary to touch the adjusters again unless a new set joins the group. Thus it will not normally be necessary to adjust QUENCH in a group of stations regularly working together. If there are more than six "B" sets on a net, it will not normally be possible to remove all the strong whistles.

CHAPTER III MAINTENANCE AND TESTING

KINDNESS PAYS

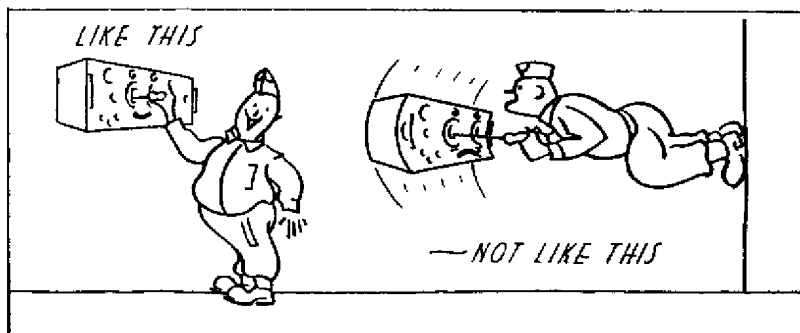

THINGS WE HAVE SEEN

1. (a) The driver, (b) the gunner, using (a) the gunner's and (b) the driver's headset. *Don't do it*; they work much better the other way.
2. The commander using the tuning knobs as a convenient step when climbing out of the turret. *Don't do it*; you might slip and graze your knee.
3. The operator removing all the locking screws from the flick dials before setting up a net. *Don't do it*; half a turn is quite enough, and there are no medals given for getting them back in the holes if anything slips.
4. The operator tapping the meter with a $\frac{3}{8}$ " spanner because it didn't show any H.T. volts. *Don't do it*; it's apt to damage the spanner and anyhow perhaps a fuse is blown.

LOOKING AFTER THE SET

18. Your job and why it is important

1. This chapter is *not* written to make you an expert electrician, able to repair every sort of breakdown. There are plenty of electricians in R. Signals to do that, and you have plenty of work of your own without trying to do theirs. But you *must* be able to do *three* things:

(a) Test the set, to see whether every bit of it is working. This is described in section 20 under **Daily maintenance**.

(b) Go all over the outside of the set, cleaning and straightening, to keep the controls, etc., running smoothly, and looking for parts which are beginning to wear out or come undone: you will often be able to put in "a stitch in time" and prevent a breakdown which might otherwise happen. The **Weekly maintenance** section 21 tells you how to do it.

(c) Repair the more common faults which may occur in the field. Some rules to help you in this are given in **Running repairs**, section 23.

The *vital* thing is that you should find out and report anything wrong *as soon as possible* so that the electricians can repair it *before the battle*: halfway through is *too late*, so it all depends on you. (See illustration on page 3.)

19. Connecting up the set and changing parts

1. Normally the set will be ready for working when you first meet it, but you may have to disconnect various parts for cleaning or replacement.

2. The kit for your set includes spares for most removable parts, so here is how to do it:—

(a) Connecting the power supply (see Figs. 11 and 12). } Do not disconnect unless

(b) Connecting aerial feeders (see Figs. 3 and 11). } replacing.

(c) Connecting up the headsets (see Figs. 11 and 6). The snatch plugs are made so that if you jump out of the tank wearing your headset they will come undone and you will not break your neck.

(d) Changing an H.T. fuse (see Figs. 11 and 13).

(e) Changing an indicator bulb (see Fig. 11).

(f) Changing an "A" aerial pigtail. Remove the aerial base by unscrewing the six fixing bolts. Then see Fig. 14. Get the electrician signals to do this if possible.

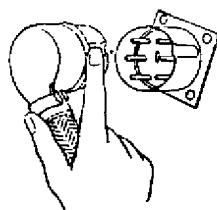

PLUGGING IN
A CONNECTOR.

Fig. 12

Fig. 11

FRONT VIEW OF SET AND SUPPLY UNIT, showing detachable parts and connections

INSET—
TAKING OFF
CONTROL UNIT
No. 1

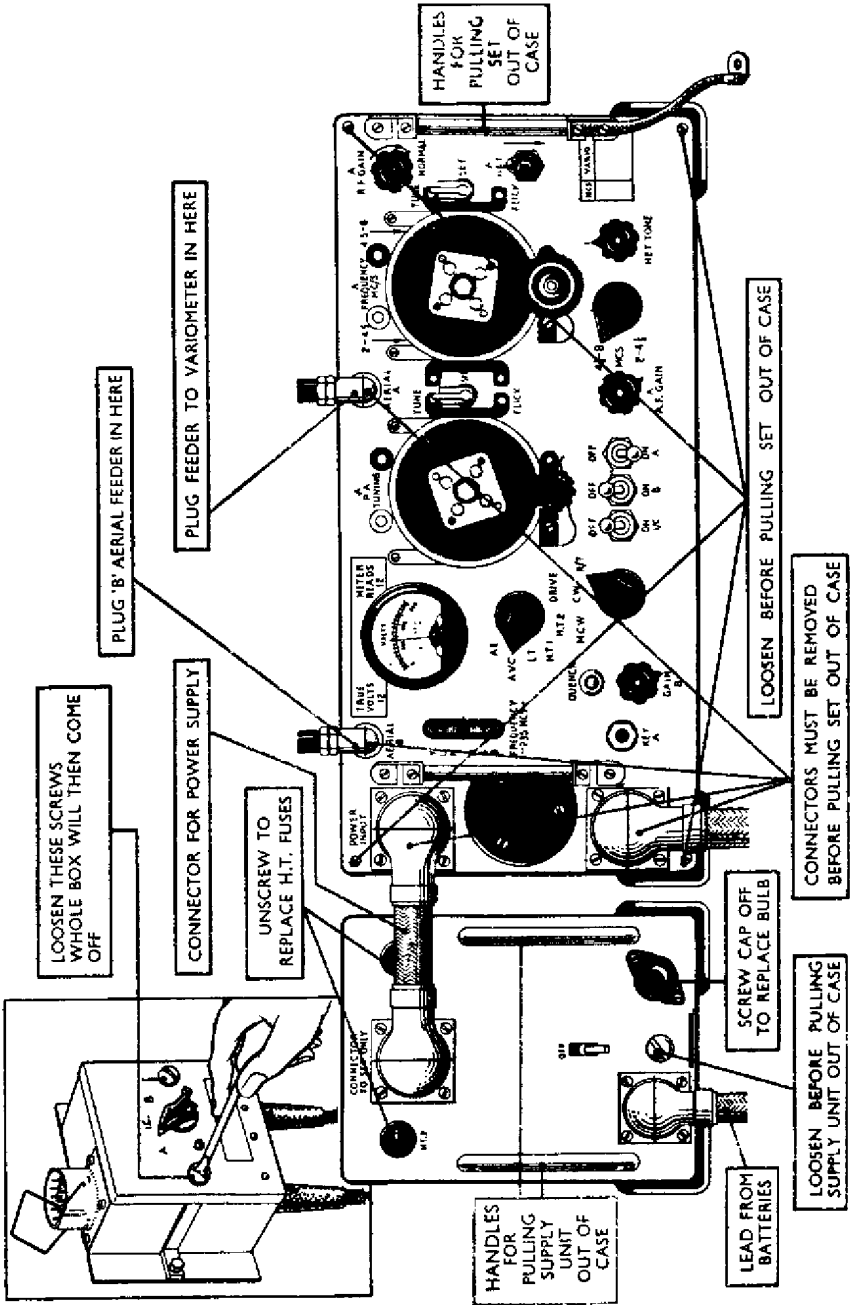

(g) Taking off the grill (see Fig. 16).

(h) Changing a fuse in control unit no. 1 (see Fig. 15).

(k) Adjusting driver's buzzer in junction distribution no. 1. Take off the box as for control unit no. 1 (Fig. 11 inset.). Adjust buzzer as in Fig. 18. *Do not adjust* except when buzzer fails.

Fig. 13.
CHANGING AN H.T. FUSE.
TAKE OLD FUSE
OUT OF CAP

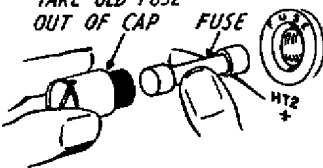

Replace with a new fuse from spare parts box.

CHANGING AN "A" AERIAL
PIGTAIL.

Fig. 14.

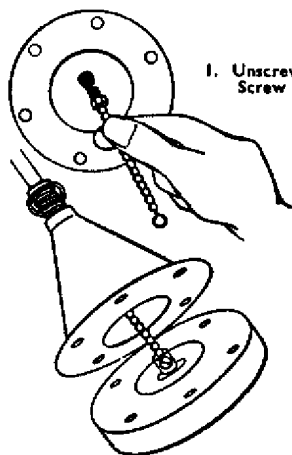

1. Unscrew old pigtail.
Screw new one in.

2. Screw eye on
bottom of pigtail
to terminal.

CHANGING A FUSE IN
CONTROL UNIT No. 1.

Fig. 15.

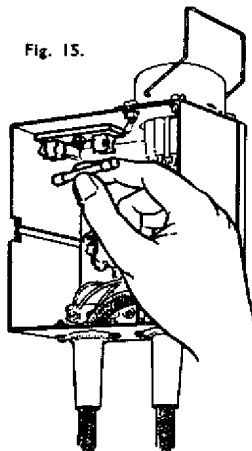

TAKING OFF THE GRILL. Fig. 16.

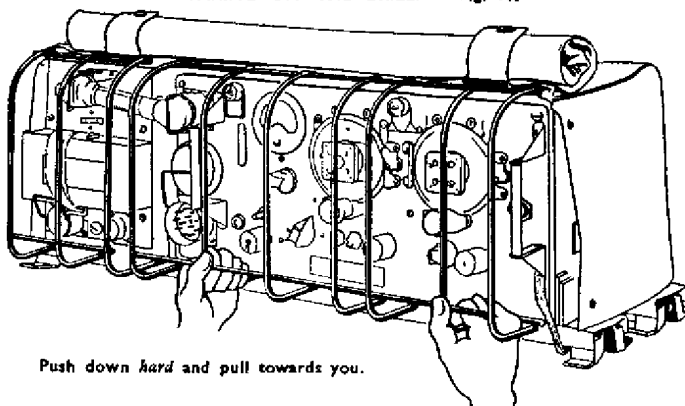

Push down *hard* and pull towards you.

CHANGING VALVES

1. Choose a new valve of the right kind from the spare valve box; all valves have their names (such as 6K7C) written on them.
2. Take the lid off the can and the cap off the valve.
3. Pull the old valve straight out of its socket.
4. Push the new one straight in (see inset).
5. Put the cap and lid back.

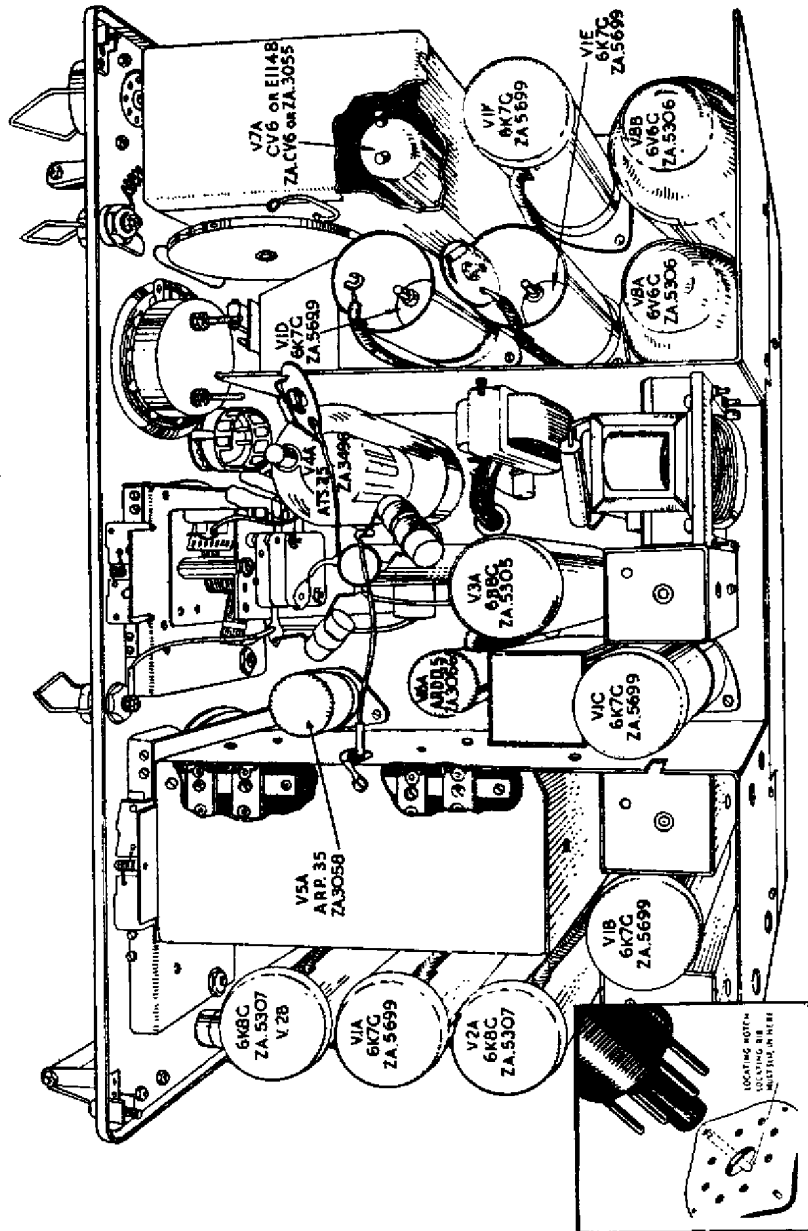
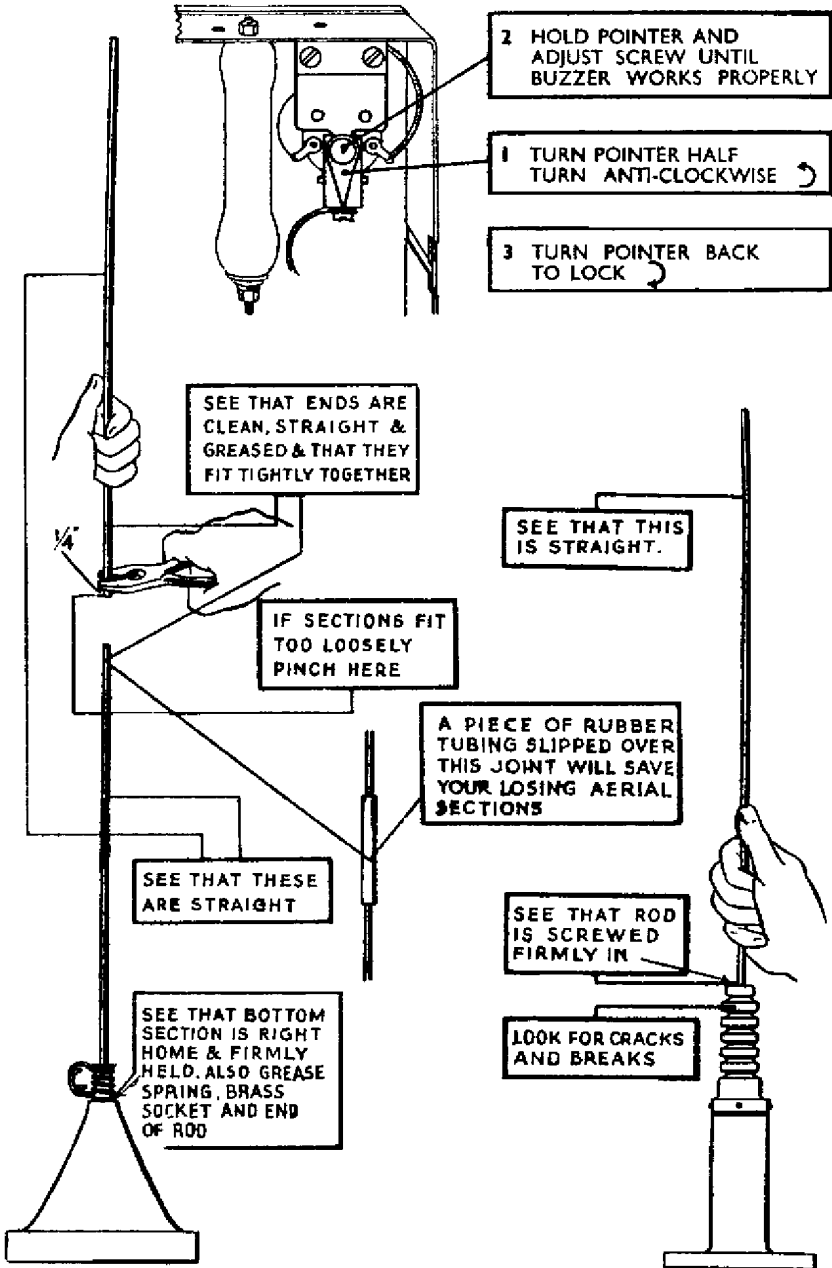

Fig. 17

HOW TO ADJUST THE DRIVER'S BUZZER

Fig. 18



AERIAL MAINTENANCE

Fig. 19

(l) Taking the set and power unit out of their cases (see Fig. 11). Never take the set out, except to change valves; never take the power unit out, except to put in a new one.

(m) Changing valves. Valves need never be touched unless the set breaks down. If this happens you may have to change a valve or two (see **Running repairs**, section 23, which will tell you which valves). To take out or put in a valve, take the set from its case and see Fig. 17. A diagram on the cover of the "B" set also shows where each valve goes. Leave changing valves to the electrician signals whenever possible; especial care is necessary with valve V7A.

20. Daily maintenance

As already explained, the set must be tested every time before it is used. Table 1 or 2 shows how to test it. The tests should be done *daily*, even though the set is not going to be used. They *must* be done in the order given. For instance, test 9 will not work unless you have just done 7.

If doing the tests shows that something is wrong and you cannot put it right with the help of this book, *report it at once* and an electrician will be sent for. *Don't* take the set to pieces in the hope of finding the fault, even though you may think you know something about the works.

21. Weekly maintenance

1. The reasons for this are given in para. 18, 1 (b).

WEEKLY MAINTENANCE

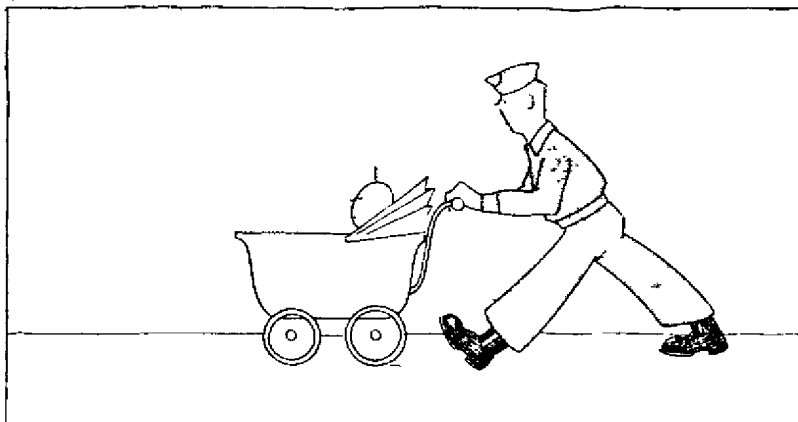

2. *Every week, without waiting to be told, you should:—*
- (a) Do your **DAILY MAINTENANCE TESTS** for the day (see Table 1 or 2).
- (b) Clean the outside of the set, supply unit and variometer with a cloth to take off dirt and grease. Don't use water, brasso, petrol or anything for making it shine.
- (c) Aerials (see Figs. 19 and 20).

"B" SET AERIAL BASE.

TO REMOVE AERIAL BASE:—

1. Remove screws "E."
2. Release spring "H," lifting aerial base far enough to allow this to be done.
3. Withdraw aerial lead.

TO REPLACE AERIAL BASE:—

1. Replace aerial lead.
2. Clip spring "H" in position on plug.
3. Secure spring "H" with a piece of copper wire as shown in inset diagram, to prevent spring from coming loose.
4. Push aerial base down on to the mounting. Secure screws "E."

TO RENEW CONNECTOR PIGTAIL:—

1. Remove aerial base.
2. Remove fixing screws "A" and "B."
3. Push insert "C" through moulding using aerial rod, at the same time removing cap "D."
4. Renew pigtail.
5. Re-assemble by pulling insert "C" through moulding by means of rod.
6. Replace screws "A" and "B."
7. Replace aerial base.

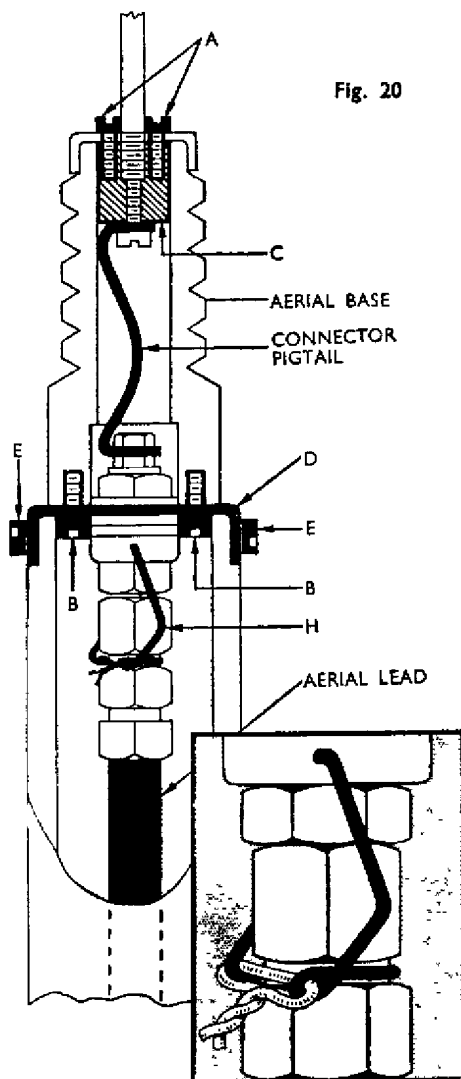
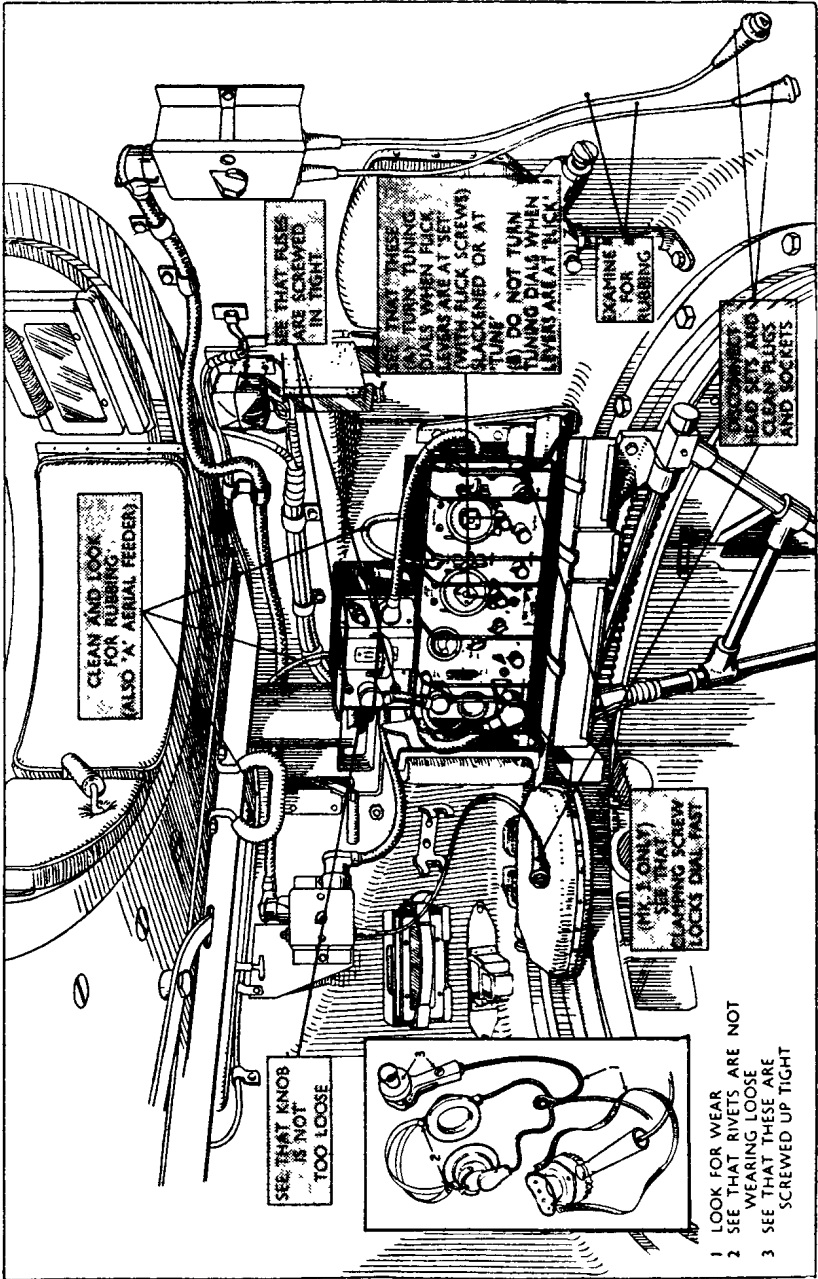

Fig. 20

WEEKLY MAINTENANCE

Fig. 21



CLEAN AND LOOK FOR RUBBING (ALSO 'A' AERIAL FEEDER)

SEE THAT KNOB IS NOT TOO LOOSE

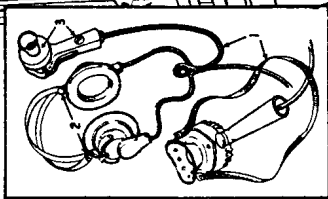

- 1 LOOK FOR WEAR
- 2 SEE THAT RIVETS ARE NOT WEARING; LOOSE
- 3 SEE THAT THESE ARE SCREWED UP TIGHT

SEE THAT RIVETS ARE SCREWED UP TIGHT

DO NOT TURN TUNING DIALS WHEN FLICK LEVERS ARE AT 'ZERO' (WITH FLICK SCREWS) SLACKENED OR AT 'TUNE'

DO NOT TURN TUNING DIALS WHEN FLICK LEVERS ARE AT 'ZERO' (WITH FLICK SCREWS) SLACKENED OR AT 'TUNE'

EXAMINE FOR RUBBING

SEE THAT SETS AND CLEAN PLUGS AND SOCKETS

(W. 3 ONLY) SEE THAT SLAMMING SCREW LOCKS DIAL FAST

CONNECTIONS BETWEEN VEHICLE AND WIRELESS EQUIPMENT Fig. 22

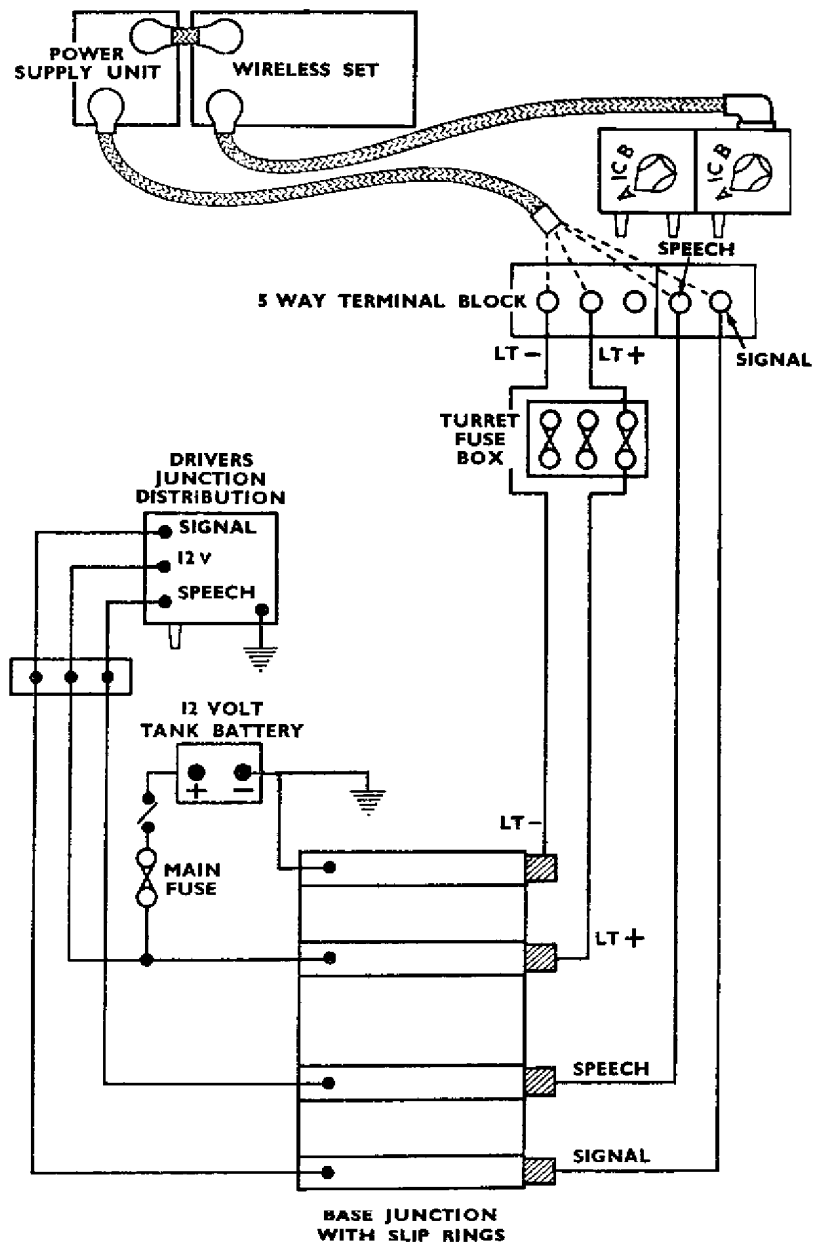

(d) Try all the controls and see that they are not jamming, nor turning so easily that their settings would alter through the shaking of the vehicle. See that no knobs are coming off their spindles: if they are, get the electrician signals to tighten the grub screws which hold them on.

(e) General:—Look at Fig. 21 and do as shown on it.

(f) Kit check:—See that you have got all your spare parts, valves and headsets. There are lists on the lids of the spare parts and spare valve cases.

(g) Report:—(i) Any faults which you have found and cannot put right.

(ii) Any missing pieces of kit.

Your maintenance is *useless* unless you do this *at once*.

(h) Batteries:—Inspect the batteries which are just as important for the wireless set as for the vehicle. Top up, clean and vaseline, etc. See that electrician signals tests electrolyte.

22. Monthly maintenance

This is *not* your job. Once a month a R. Signals electrician will inspect your set thoroughly and overhaul it where necessary.

23. Running repairs

1. If the set or any part works badly or stops working, try the cure for the particular failure as shown in Table 3.

2. When replacing valves work on the lines of these two examples:—

(a) Failure no. 3, due to V1B burning out:—Put in new V1A, test set—no result. Put in new V1B, test set—set works, therefore V1B faulty. Put old V1A back, test set—set still works, therefore old V1A is sound.

(b) Failure no. 4, due to V2B and V5A, *both* burning out:—Put in new V2B, test set—no result. Put in new V4A, test set—no result. Put in new V5A, test set—set works, therefore V5A faulty. Put old V2B back, test set—set does not work, so V2B faulty; put new V2B in again. Put old V4A back, test set—set works, therefore old V4A is sound.

3. *Do not* put faulty valves back in the spare valve case: exchange them for sound ones as soon as possible and put the sound ones back in the case.

TABLE I

TABLE OF TESTS FOR DAILY MAINTENANCE OF No. 19 SETS MKS. I AND II

<i>Part of set tested.</i>	<i>No.</i>	<i>Test.</i>	<i>What should happen.</i>	<i>What should NOT happen.</i>	<i>What is likely to be wrong.</i>	<i>What to do about it.</i>			
POWER SUPPLY.	1	Put switch on supply unit to ON.	Red lamp on supply unit lights and machine runs.	(a) Machine does not run. Lamp does not light.	i. Batteries flat. ii. Lead from battery not plugged in. iii. Vehicle master switch OFF.	Carry out test 2. Plug in; check connections. Switch ON.			
							(b) Machine runs but lamp does not light.	Bulb burnt out.	Replace bulb.
							Meter reads at least normal, about 11-12 volts.	i. Batteries need charging.	Run engine or charger.
H.T. VOLTAGE SUPPLY.	2	METER switch to L.T.	Meter reads at least normal, about 11-12 volts.	(a) Meter reads below 10.5 or 10 volts.	i. Rotary base junction dirty.	Rotate turret 2 or 3 times.			
							3	METER switch to H.T.1.	Meter about 275 volts.
4	METER switch to H.T.2.	Meter about 500 volts.	ii. Internal fault.	Report. In emergency check H.T. brushes.					
					'C' SYSTEM AND HEADSETS.	5	A ONLY-ALL to ALL and control unit to "C". Press pressel and speak. Test all headsets.	Your voice is heard in all the headsets of the tank, including your own.	i. Switch plug connections bad.
6	Press button on junction distribution no. 1.	Buzz heard in phones.	ii. Faulty headset.	Replace headset.					
								No buzz in phones.	iii. Internal fault.
				Buzzer needs adjusting.					

TABLE I—continued.

Part of set tested.	No.	Test.	What should happen.	What should NOT happen.	What is likely to be wrong.	What to do about it.
"A" RECEIVER.	7	Switch on control unit to "A." System switch to RT and METER to AVC. Tune in to any strong RT station on each waveband in turn. (A broadcast will do.)	(a) Station is heard in phones. (b) Meter reading is less when set is turned to station than when it is not.	1. No station can be heard. 2. Station is heard but very noisy.	i. Aerial disconnected. ii. Receiver faulty. Loose connections.	Examine all connections including pigtail. Report. See running repairs 3 and 6. Check aerial connections. Report. See running repairs 11.
	8	Press NET button with strength 5 signal. Adjust A FREQUENCY MCS.	Whistle is heard.	No whistle is heard.	Internal fault. Internal fault.	Report. (Set may be efficient enough to be used in an emergency.) Report. See running repairs 5.
"A" SENDER, NOT TO BE TESTED IF UNDER WIRELESS SILENCE.	9	Put meter switch to AE. Press preset switch and tune with A PA TUNING and VARIO-METER for highest possible meter reading.	Meter reads its usual value.	Meter does not read or reads very low.	i. Preset-switch not working. ii. Aerial connections faulty. iii. Sender faulty.	Try another headset. If still no good, report. Check all connections. Report. See running repairs 4, 5, 7, 8 and 9.
	10	Speak loudly into microphone.	(a) Meter needle kicks. (b) Sidetone is heard.	Meter reading does not alter. No sidetone.	Internal fault. Internal fault.	Report. See running repairs 6. Report, but set may still send well. See running repairs 6.

TABLE I—*continued.*

<i>Part of set tested.</i>	<i>No.</i>	<i>Test.</i>	<i>What should happen.</i>	<i>What should NOT happen.</i>	<i>What is likely to be wrong.</i>	<i>What to do about it.</i>
MORSE KEY AND CW RECEPTION.	11	(a) Switch set to CW. Move HET. TONE control. (b) Plug in key and press.	Whistle is heard varying in pitch as control is moved. Meter reads a little higher than test 9.	Whistle does not vary. Meter does not read or reads very low.	Internal fault. i. Fault in key or key-lead. ii. Internal fault.	Report, but set will still function except on CW reception. See running repairs 5. Check key and plug. Report. See running repairs 10.
MCW	12	Switch to MCW and press key. (N.B. Not under Wireless Silence.)	Whistle heard in phones.	No whistle heard.	Internal fault.	Report. See running repairs 6.
"B" RECEIVER.	13	Switch OFF-ON B to ON. Put switch on control unit to "B." Turn up GAIN E.	Hiss in phones.	(a) Nothing heard in phones. (b) Hiss in phones; reception very noisy.	Internal fault. Loose connections.	Try flicking pressed switch. Report. See running repairs 18. Check aerial leads. Report. See running repairs 17.
"B" SENDER. NOT UNDER WIRELESS SILENCE.	14	Press pressed-switch and speak.	Hiss disappears and sidetone is heard.	Hiss is still heard or your own voice is not heard.	Internal fault.	Report. See running repairs 15.
PILOT LAMP.	15	Put switch on both control units to "B."	Red lamp lights on operator's control unit.	Lamp does not light.	i. Bulb burnt out. ii. Fuse blown.	Replace bulb. Replace fuse in control unit no. 1.
RE-TRANS-MISSION. NOT UNDER WIRELESS SILENCE.	16	Switch control unit MR. II to "R" and "A→B." (b) "B→A." (c) "A and B." (d) Press pressed switch.	(a) "B" set switched to SEND. (b) "A" set ditto. (c) Both sets on RE-CEIVE. (d) Both sets on SEND. Controls should feel "smooth" and work.	(a) & (b) Misch continues in commander's phones when switched to set which should be on SEND. (c) One or both on SEND. (d) As (a) and (b). Controls jam, feel "rough" or fail to work.	Internal fault.	Report.
GENERAL.	17	Check all controls when receiving.	Controls should feel "smooth" and work.	Controls jam, feel "rough" or fail to work.	Internal fault.	Report.

TABLE 2
TABLE OF TESTS FOR DAILY MAINTENANCE OF NO. 19 SETS Mk. III

<i>Part of set tested.</i>	<i>Test.</i>	<i>What should happen.</i>	<i>What should NOT happen.</i>	<i>What is likely to be wrong.</i>	<i>What to do about it.</i>	
POWER SUPPLY.	1 Put switch on supply unit to ON.	Red lamp on supply unit lights and one machine runs.	(a) Machine does not run. Lamp does not light.	i. Batteries flat.	Carry out test 2.	
				ii. Lead from battery not plugged in.	Plug in connections.	
				iii. Vehicle master switch OFF.	Switch ON.	
				iv. Battery not properly connected.	Connect if possible.	
I.T. VOLTAGE SUPPLY.	2 Meter switch to L.T.	Meter reads at least normal, about 11-12 volts.	(b) Machine runs but lamp does not light.	Bulb burnt out.	Replace bulb.	
				(c) Lamp lights steadily but machine does not run properly.	Machine out of order.	Report. In emergency open unit and check L.T. brushes.
				Meter reads below 10.5 or 10 volts.	i. Batteries need charging.	Run engine or charger.
H.T.1 VOLTAGE SUPPLY.	3 Meter switch to H.T.1.	Meter reads about 275 volts.	(a) Meter reads zero.	Fuse blown.	Replace fuse.	
				(b) Meter reads low.	H.T.1 machine out of order.	Report. In emergency check H.T.1 brushes.
H.T.2 VOLTAGE SUPPLY.	4 Control unit to "A." A OFF-ON switch to ON. Meter switch to H.T.2. System switch to RT. Press pressed.	(a) 2nd machine runs.	(c) 2nd machine does not run.	Faulty I.T. brushes.	Try test 5.	
				Faulty relay in supply unit.	Examine relay.	
"IC" SYSTEM AND HEADSETS.	5 Control unit to "IC" OFF-ON IC switch to ON. Press pressed and speak. Test all headsets including microphone.	(b) Meter reads about 500 volts.	(b) Machine runs, but no meter reading.	Fuse blown.	Replace fuse.	
				Faulty H.T. brushes.	Check brushes.	
				i. Snatch plug connections bad.	Clean and check.	
6 Press button on junction distribution no. 1.	6 Press button on junction distribution no. 1.	Buzz heard in phones.	No buzz in phones.	ii. Faulty headset.	Replace headset.	
				iii. Internal fault.	Report. See running repairs 13 and 14.	
				Buzzer needs adjusting.	Adjust buzzer.	

TABLE 2—continued.

Part of set tested.	No.	Test.	What should happen.	What should NOT happen.	What is likely to be wrong.	What to do about it.
"A" RECEIVER.	7	System switch to RT and meter switch to A.V.C. Turn both <i>gains fully clockwise</i> . Tune in to any strong RT station on each waveband in turn. (A broadcast will do.)	(a) Station heard in phones.	i. No station can be heard.	i. Aerial disconnected.	Examine all connections including plugtail. Report. See running repairs 3 & 6.
			(b) Meter reading is less when set is tuned to station than when it is not.	Whistle is heard.	ii. Station heard but very noisy.	ii. Receiver faulty.
"A" SENDER. NOT TO BE TESTED IF UNDER WIRELESS SILENCE.	8	Turn netting switch down. Adjust A FREQUENCY dial.	Whistle is heard.	No whistle heard.	Internal fault.	Report. See running repairs 5.
			Meter reads its usual value.	Meter does not read or reads very low.	i. Aerial connection faulty.	Check all connections.
MORSE KEY and CW RECEPTION.	9	Put meter switch to A.E. Press press-switch and tune VARIOMETER and A P.A. for highest possible meter reading.	Meter reads its usual value.	Meter reading does not alter.	ii. Sender faulty.	Report. See running repairs 4, 5, 7, 8 and 9.
			Speak loudly into the microphone.	(a) Meter needle kicks.	Meter reading does not alter.	Internal fault.
MORSE KEY and CW RECEPTION.	10	(a) Switch set to CW. Move HET. TONE control.	(b) Sidetone is heard.	No sidetone.	Internal fault.	Report, but set may still send. See running repairs 6.
			(b) Plug in key and press.	Whistle heard varying in pitch either side of zero mark.	Whistle does not vary.	Internal fault.
MCW.	11	(b) Plug in key and press.	Meter reads higher than test 9.	Meter does not read or reads very low.	i. Fault in key or key lead.	Check key, plug and lead.
			(a) Switch to MCW, press key.	Whistle in phones.	ii. Internal fault.	Report. See running repairs 10.
MCW.	12	(a) Switch to MCW, press key.	Whistle in phones.	No whistle in phones.	Internal fault.	Report. See running repairs 5.
			(b) Return switch to RT.			

TABLE 2—continued.

Part of set tested.	No.	Test.	What should happen.	What should NOT happen.	What is likely to be wrong.	What to do about it.
"B" RECEIVER.	13	Switch OFF-ON B to ON. Put switch on control unit to "B." Turn up GAIN B.	Hiss in phones.	(a) Nothing heard in phones. (b) Hiss in phones; reception very noisy.	Internal fault. Loose connections.	Try flicking pressel switch. Report. See running repairs 16.
"B" SENDEE. NOT UNDER WIRELESS SILENCE.	14	Press pressel-switch and speak.	Hiss disappears and sidetone is heard.	Hiss is still heard or your own voice is not heard.	Internal fault.	Check aerial leads. Report. See running repairs 17.
PILOT LAMP.	15	Put switch on both control units to "B."	Red lamp lights on operator's control unit.	Lamp does not light.	I. Bulb burnt out. II. Fuse blown.	Replace bulb. Replace fuse in control unit no. 1.
RE-TRANSMISSION. NOT UNDER WIRELESS SILENCE.	16	Switch control unit Mk. II to "R" and (a) "A→B." (b) "B→A." (c) "A and B." (d) Press pressel-switch.	(a) "B" set switched to SEND (b) "A" set ditto. (c) Both sets on RECEIVE. (d) Both sets on SEND.	(a) & (b) Much continued in commander's phones which switched to sets which should be on SEND. (c) One or both on SEND. (d) As (a) and (b).	Internal fault.	Report.
GENERAL.	17	Check all controls when receiving.	Controls should feel "smooth" and work.	Controls jam, feel "rough" or fail to work.	Internal fault.	Report.

TABLE 3
RUNNING REPAIRS

<i>Failure.</i>	<i>Possible cause.</i>	<i>Possible cure.</i>
<i>Power.</i> 1. Set completely dead.	Failure of power.	Do tests 1 to 5 of daily maintenance tests.
<i>"A" Set.</i> 2. All working except "A" set sender and receiver.	(1) Aerial disconnected. (2) V4A, V2A, V3A, V1A.	Examine and replace pig-tail if necessary. Replace valves in turn.
3. All working except "A" receiver.	V1A, V1B, V1C.	Replace valves in turn.
4. All working except "A" sender.	V2B, V4A, V5A, V6A.	Replace valves in turn.
5. All working except "A" sender, though "A" receiver gives no CW note or netting whistle.	V2B.	Replace valve.
6. All working except "A" receiver, and meter reading does not rise when sending RT. (See daily maintenance test no. 10.)	V3A.	Replace valve.
7. "A" sender and receiver not working, but your own voice heard in phones on sending RT.	V2A.	Replace valve.
8. All working except "A" sender, but meter reads with switch set to DRIVE.	V4A.	Replace valve.
9. All working except "A" sender. No reading or only a very low reading with switch set to DRIVE.	V2B, V5A.	Replace valves in turn.
10. All working except "A" sender on morse.	(1) Faulty key, key-lead or plug. (2) Internal fault.	Examine. Repair if possible, otherwise report.
11. "A" receiver very noisy.	(1) Loose aerial connections. (2) Loose valves.	Report. Check, tighten where loose and replace pig-tail if necessary.
12. Pilot light on operator's control unit out.	(1) Bulb burnt out. (2) Fuse burnt out.	See daily maintenance test no. 15.
13. All working except "IC."	V1F, V8B.	Replace valves in turn.
14. "B" and "IC" not working.	V1F, V1E, V8B, V8A.	Replace valves in turn.
<i>"B" Set.</i> 15. All working except "B" set sender and receiver.	V7A, V1D, V1E, V8A.	Replace valves in turn.
16. All working except "B" set receiver.	V1D.	Replace valve.
17. "B" receiver very noisy.	(1) Loose aerial connections. (2) Loose valves.	Check, tighten where loose. <i>Warning.</i> "B" aerial feeder is very fragile.

PREPARE SET FOR NETTING

Mks. I & II

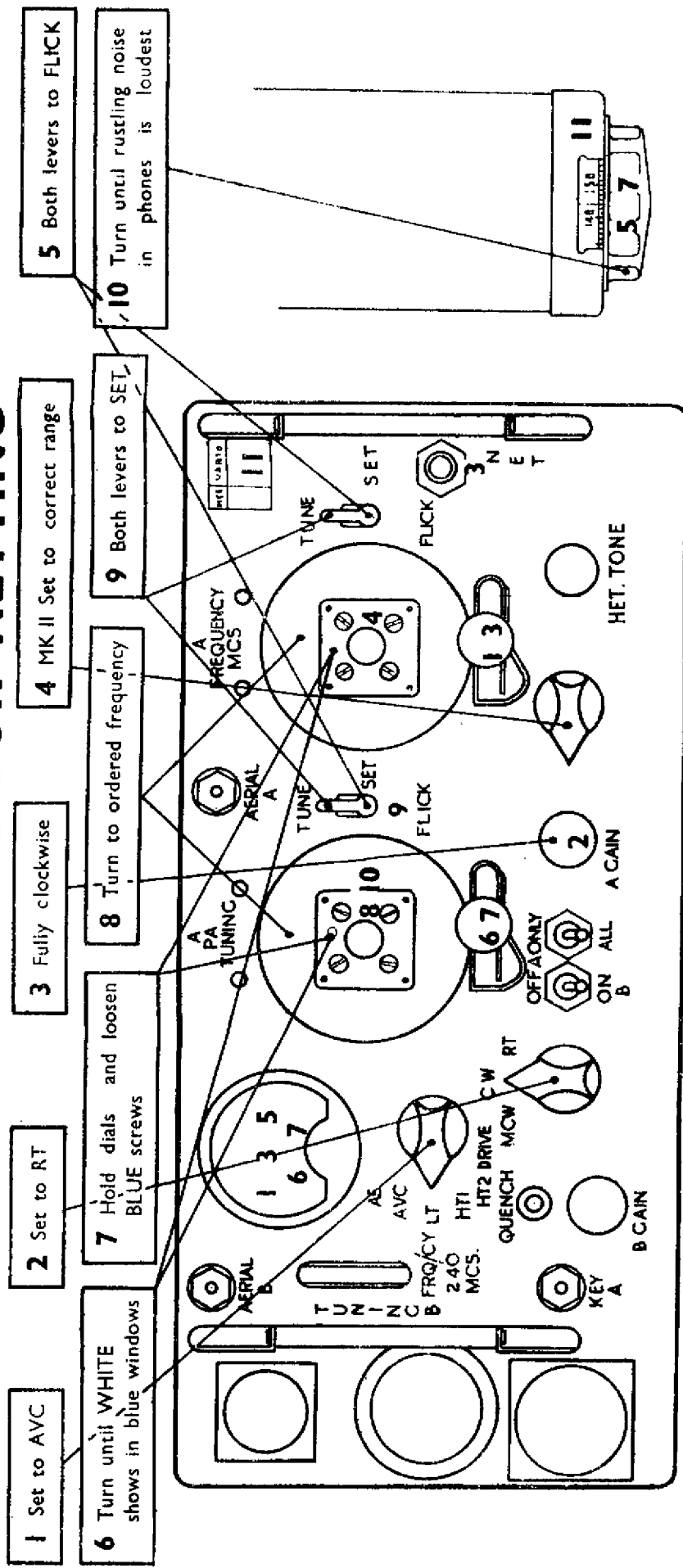

- 1 Set to AVC
- 2 Set to RT
- 3 Fully clockwise
- 4 MK II Set to correct range
- 5 Both levers to FLICK
- 6 Turn until WHITE shows in blue windows
- 7 Hold dials and loosen BLUE screws
- 8 Turn to ordered frequency
- 9 Both levers to SET
- 10 Turn until rustling noise in phones is loudest

NETTING IN HARBOUR

NETTING DRILL

Use the numbers here for NETTING BY NUMBERS when training

- 1 Search boldly for control, choose signal giving max. dip on A.V.C.
- 2 Reduce A GAIN to give strength of 2 signal
- 3 Press NET, tune A FREQUENCY dial to zero beat and max. dip
- 4 Lock correct screws of A FREQUENCY dial
- 5 Adjust VARIOMETER for max. dip on AVC. See para 16, 4. Warning
- 6 Adjust A PA TUNING for max. dip on AVC
- 7 Readjust VARIOMETER and A PA for max. dip
- 8 Lock A PA TUNING screws
- 9 Turn A PA TUNING to FLICK
- 10 Turn A PA TUNING away at least one MC/S
- 11 Note VARIOMETER reading on tablet and in log



Fig. 3

PREPARE SET FOR NETTING

Mk. III

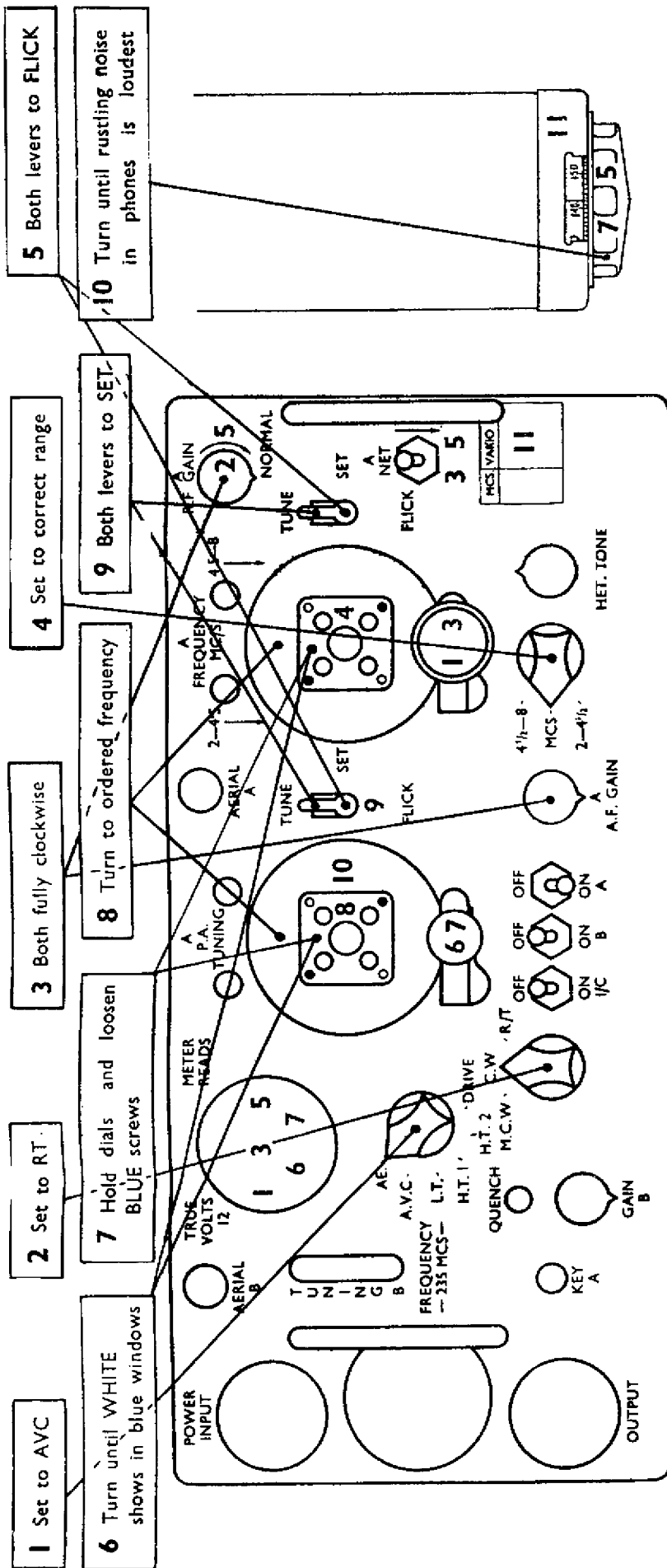

NETTING IN HARBOUR

NETTING DRILL

Use the numbers here for NETTING BY NUMBERS when training

- 1** Search boldly for control, choose signal giving max. dip on A.V.C.
- 2** Reduce R.F. GAIN to give strength 2 signal
- 3** Switch to NET, tune A FREQUENCY dial to give zero beat and max. dip
- 4** Lock correct screws of A FREQUENCY dial
- 5** NET switch up R.F. GAIN to NORMAL, Adjust VARIOMETER for max. dip on AVC METER. See para 16, 4. *Warning*
- 6** Adjust A PA TUNING for max. dip on AVC
- 7** Readjust VARIOMETER and A PA for max. dip
- 8** Lock A PA TUNING screws
- 9** Turn A PA TUNING to FLICK
- 10** Turn A PA TUNING away at least one MC/S
- 11** Note VARIOMETER reading on tablet and in log

Fig. 9