

RECEIVER R.1132A and ANCILLARY EQUIPMENT

LIST OF CHAPTERS

Note.—A list of contents appears at the beginning of each chapter.

CHAPTER 1—Receiver R.1132A

CHAPTER 2—Receiver R.1481

CHAPTER 3

(To be issued later)

**CONCISE DETAILS OF
RECEIVER R.1132A**

PURPOSE OF EQUIPMENT	Ground station rack assembly receiver for V.H.F. communication or direction finding. Incorporates A.G.C. manual gain control for D.F. with local oscillator for audible beat production. Also issued for mobile application with transmitter vehicle (Stores Ref.10D/439)		
TYPE OF WAVE	R/T unmodulated carrier for D/F		
FREQUENCY RANGE	100 Mc/s to 124 Mc/s		
FREQUENCY STABILITY	Not applicable		
CRYSTAL MULT. FACTOR	Not applicable		
PERCENTAGE MODULATION	Not applicable		
MAXIMUM SENSITIVITY	Aerial circuit signal of 20 microvolts, modulated 100 per cent, fully loads output valve		
SELECTIVITY	I.F. signal attenuated 70-db from desired signal		
OUTPUT IMPEDANCE	Normally 600 ohms, but satisfactory between 200 ohms and 2,000 ohms		
AMPLIFIER CLASS	Not applicable		
MICROPHONE TYPE	Not applicable		
VALVES	Pre-selector CV1065 Frequency changer CV1065 Oscillator CV1066 I.F. amplifier (3) CV1053	Signal and A.G.C. rectifier CV1054 Variable gain A.F. amplifier CV1057 Triode output CV1067 Neon stabilizer CV1070	
POWER INPUT	A.C. mains with power unit, type 3 (190 v. to 250 v.), (Stores Ref. 10K/11517) 6 volt accumulators with power unit, type 4A (emergency)		
POWER OUTPUT	Max. 250 milliwatts		
STORES REF. NO.	10D/105		
APPROXIMATE OVERALL DIMENSIONS	LENGTH 19 in.	WIDTH 10½ in.	HEIGHT 10½ in. Rack mounted
WEIGHT	—		
ASSOCIATED EQUIPMENT	The receiver is part of the rack assembly type 1A (Stores Ref. 10A/12078), type 2 (Stores Ref. 10A/11520) type 3A (Stores Ref. 10A/12077), type 4A (Stores Ref. 10A/12132) type 8 (Stores Ref. 10A/12320), type 9 (Stores Ref. 10A/12321) type 10 (Stores Ref. 10A/12322) Crystal monitor, type 4 (Stores Ref. 10T/46) Power unit, type 3 (Stores Ref. 10K/11517) In emergency, power unit, type 4A (Stores Ref. 10K/45) from 6-volt accumulators Receiver, telephone, head, type B (Stores Ref. 10A/8542) Aerial system, type 2A (Stores Ref. 10B/167), or type 3 (Stores Ref. 10A/11847), or type 10 (Stores Ref. 10/B104)		

CHAPTER 1

RECEIVER R.1132A

LIST OF CONTENTS

	<i>Para.</i>
Introduction	1
General description	7
Constructional details	19
Valves and power supply	29
Installation	31
Operation	33
Precautions	43
Alignment	49
Fault-finding chart	54
Valve voltages	55
Nomenclature of parts	Appendix 1

LIST OF ILLUSTRATIONS

	<i>Fig.</i>
Receiver R.1132A, front view... ..	1
Receiver R.1132A, theoretical circuit diagram	2
R.1132A, bench wiring diagram, top side of chassis	3
R.1132A, bench wiring diagram, underside of chassis	4
Earthing bridges, bench wiring diagram	5
Interior view, showing valves... ..	6
Underside view of chassis	7
R/F unit, cover removed	8
R/F unit, rear view	9
R/F unit, underside view	10
Beat frequency oscillator interior view	11
Valve holder connexion	12

CHAPTER 1

RECEIVER R.1132A

(Stores Ref. 10D/105)

INTRODUCTION

1. The receiver R.1132A is intended for use as a ground station receiver. It has been specially designed for use on the very high-frequency band between 100 and 124 Mc/s and may be used for R/T communication or D/F. The instrument has exceptionally good automatic gain control and frequency stability. These features ensure that as a communication receiver it will function for long periods with the minimum amount of monitoring. In order to satisfy direction finding requirements a manual gain control is provided and a local oscillator is included to give an audible beat when receiving an unmodulated carrier wave.

2. The receiver employs a superheterodyne circuit and consists essentially of a signal frequency R/F amplifier followed by a frequency changer with a separate oscillator valve, three I/F amplifier stages, a double diode detector and A.G.C. rectifier, and two stages of audio-frequency amplification. There is also a beat frequency oscillator which may be switched into the detector circuit when necessary. The four main tuning condensers are ganged together by flexible couplings and operated through a slow motion drive fitted with a calibrated scale. In general use the receiver output will be fed into a telephone line, and the output impedance has been chosen to satisfy this requirement. The maximum sensitivity of the receiver is such that a signal of 20 microvolts in the aerial circuit modulated 100 per cent will fully load the output valve. A signal of 10 microvolts in the aerial circuit is sufficient to overcome the A.G.C. delay voltage. The signal to noise ratio of a signal of 10 microvolts modulated 30 per cent at 1,000 c/s is greater than 12 db. When the beat frequency oscillator is used to give a tone frequency, satisfactory direction finding can be achieved on signals of approximately 1 microvolt.

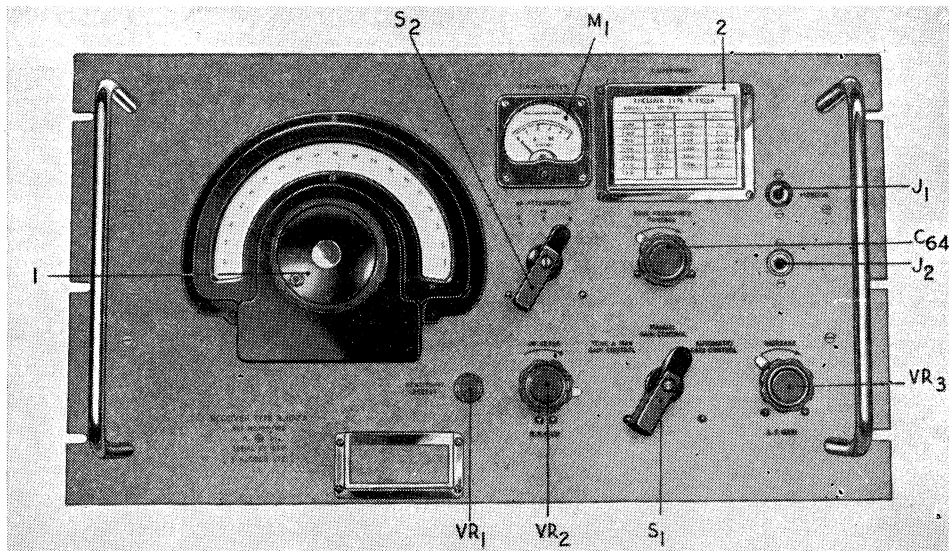

Fig. 1.—Receiver R.1132A, front view

3. The image response of the receiver as well as all other undesired responses is attenuated at least 70 db. from the desired frequency response. A signal at the intermediate frequency applied to the input of the receiver will be attenuated at least 70 db. from the level of the desired signal.

4. The efficiency of the A.G.C. system is such that an increase in the input signal strength of from 20 to 100 microvolts will not cause the output voltage to vary by more than 2 to 1, namely 6 db.

5. The audio-frequency response to the receiver R.1132A is adjusted to give maximum intelligibility when receiving from the transmitter-receivers T.R.1143, T.R. 1430, etc. The response is level between 800 and 3,000 c/s, but it falls off below 700 c/s and at 400 c/s it is 6 db down. The reproduction of frequencies less than 300 c/s is negligible. Frequencies higher than 3,000 c/s are also attenuated, and at 3,500 c/s the response is 6 db down. A series noise limiter is incorporated in the second detector circuit to suppress various types of pulse interference emanating from radar equipment.

6. Normally, the receiver functions from A.C. supply mains in conjunction with the power unit, Type 3. For emergency operation, however, the receiver may be operated from a 6-volt accumulator using the power unit, Type 4, which incorporates a rotary transformer.

GENERAL DESCRIPTION

7. A front view of the receiver is illustrated in *fig. 1* and a theoretical circuit diagram is given in *fig. 2*. The tuning is effected by means of the ganged variable condensers C_3 , C_{10} , C_{11} and C_{21} . Each tuning condenser is shunted by a small pre-set trimmer, which is used for initial alignment.

8. The aerial is coupled to the first tuned circuit L_1 , C_3 by the condenser C_1 . The R/F valve V_1 does not provide much amplification, but increases the selectivity and secures freedom from second channel interference. The resistance R_1 provides some damping in the aerial circuit and improves the stability of the R/F stage. Self-bias is applied to the cathode and A.G.C. bias to the grid.

9. The output from the R/F amplifier is coupled to the frequency changer V_2 through a band-pass circuit. Three circuits, tuned to the signal frequency, are included before the frequency changer in order to reduce cross-modulation effects and second-channel interference from powerful transmitters on adjacent frequencies. The condenser C_{17} is included in series with the grid of the valve in order to reduce the damping effect of the valve input capacitance on the tuned circuit. The oscillator frequency is introduced into the frequency changer by cathode injection through the resistance R_{80} . The oscillator frequency differs from the signal frequency by 12 Mc/s and the oscillator is always tuned to the lower frequency. The neon tube V_4 stabilizes the anode voltage of V_3 and thus helps to maintain a constant oscillator frequency. A variation in oscillator anode voltage of only one volt is sufficient to change the oscillator frequency by 3 kc/s.

10. Three pentode I/F amplifier stages, transformer-coupled are used. The first I/F transformer windings are damped, ensuring a smooth response curve. Screens are fitted between the inductances of the I/F transformers to reduce the coupling, and to avoid alterations in the intermediate frequency with change of gain, a certain amount of negative feedback is introduced by leaving the cathode resistances R_{14A} , R_{22A} and R_{25A} unby-passed. The response characteristic of the I/F amplifier is flat within 6 db for a band-width of 100 kc/s with a rapid attenuation of 60 db for a band-width of 50 kc/s.

11. The screen grids of the first two I/F amplifier valves V_5 and V_6 are maintained at a constant voltage by potential dividers. The use of a series feed resistance R_{27} results in a sliding potential on the screen of V_8 . Since a shorter grid base is obtained with a fixed than with a sliding grid potential, the A.G.C. voltage is most effective in the stages associated with V_5 and V_6 ; the longer grid base of V_8 reduces cross-modulation.

12. The anode current of the first I/F valve V_5 is measured by the meter M_1 . This serves as a tuning indicator when using A.V.C. The gain of the I/F stages may be adjusted by the pre-set resistance VR_1 , connected in series with the common cathode return lead. It is normally set in the position which gives maximum gain.

13. The A.G.C. switch S, has three positions. In the right-hand position, engraved AUTOMATIC GAIN CONTROL, the R/F gain control VR_2 connected in the common cathode return lead of the three I/F amplifier valves is short-circuited, and the R/F gain of the receiver is regulated entirely by the action of the A.G.C. system.

14. When the A.G.C. switch is set to the middle position, engraved MANUAL GAIN CONTROL, both the A.G.C. lines are earthed, and the R/F gain of the receiver depends on the setting of VR_2 .

15. In the left-hand position, engraved TONE & MANUAL GAIN CONTROL, the H.T. supply to V_7 is switched on and the beat frequency oscillator comes into operation. The beat frequency oscillator has been included in the instrument in order to enable D/F bearings to be taken on an unmodulated carrier. The output from the oscillator valve, which may be varied between 11.9 and 12.1 Mc/s, is injected into the second detector through the condensers C_{50} and C_{40} . Since the intermediate frequency is 12 Mc/s, an audible beat note will be produced. The pitch of the note may be varied by the condenser C_{64} .

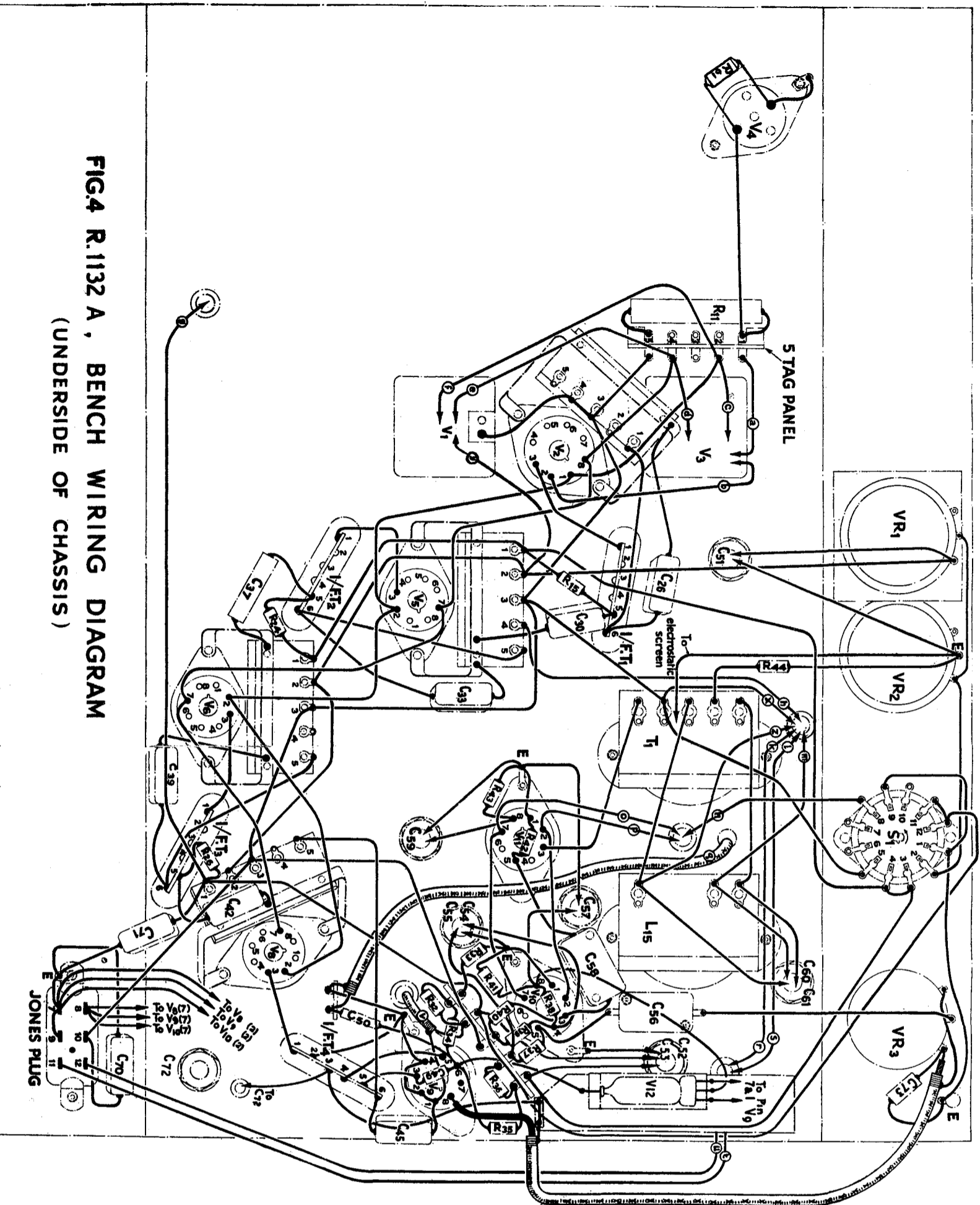
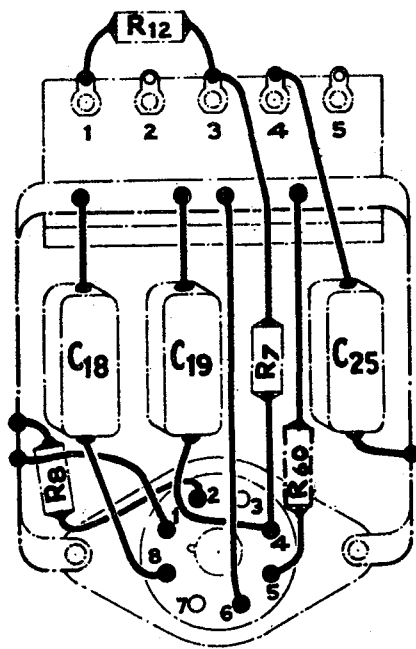
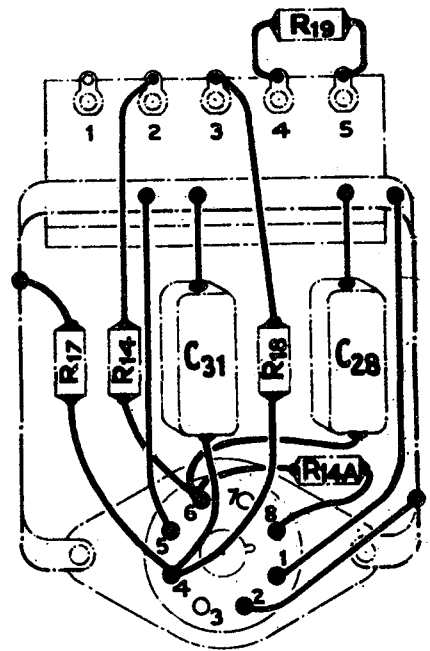

FIG 4 R.1132 A , BENCH WIRING DIAGRAM
(UNDERSIDE OF CHASSIS)



V₂



V₅

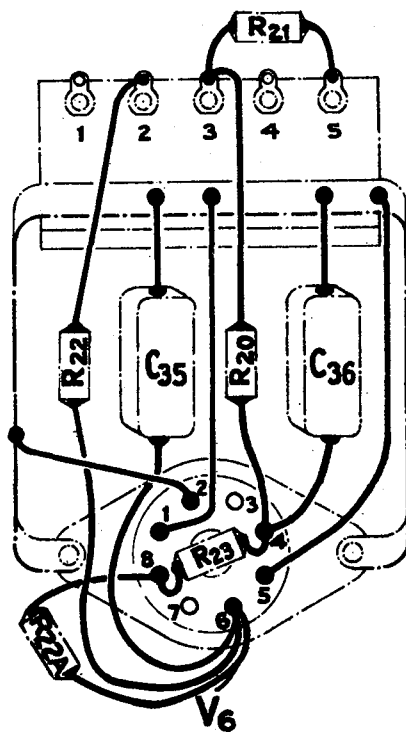

V₆

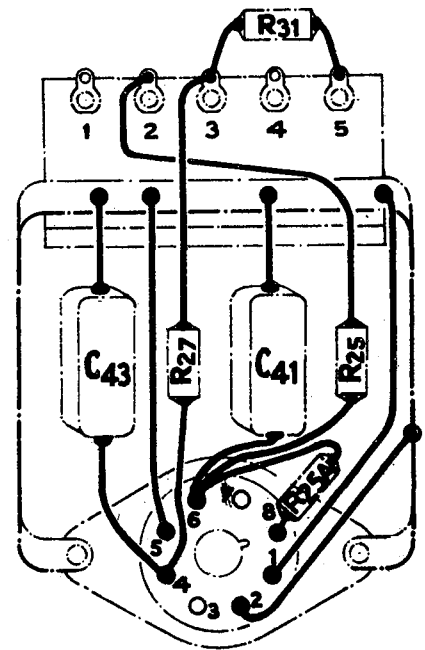

V₈

FIG.5

EARTHING BRIDGES, BENCH WIRING DIAGRAM

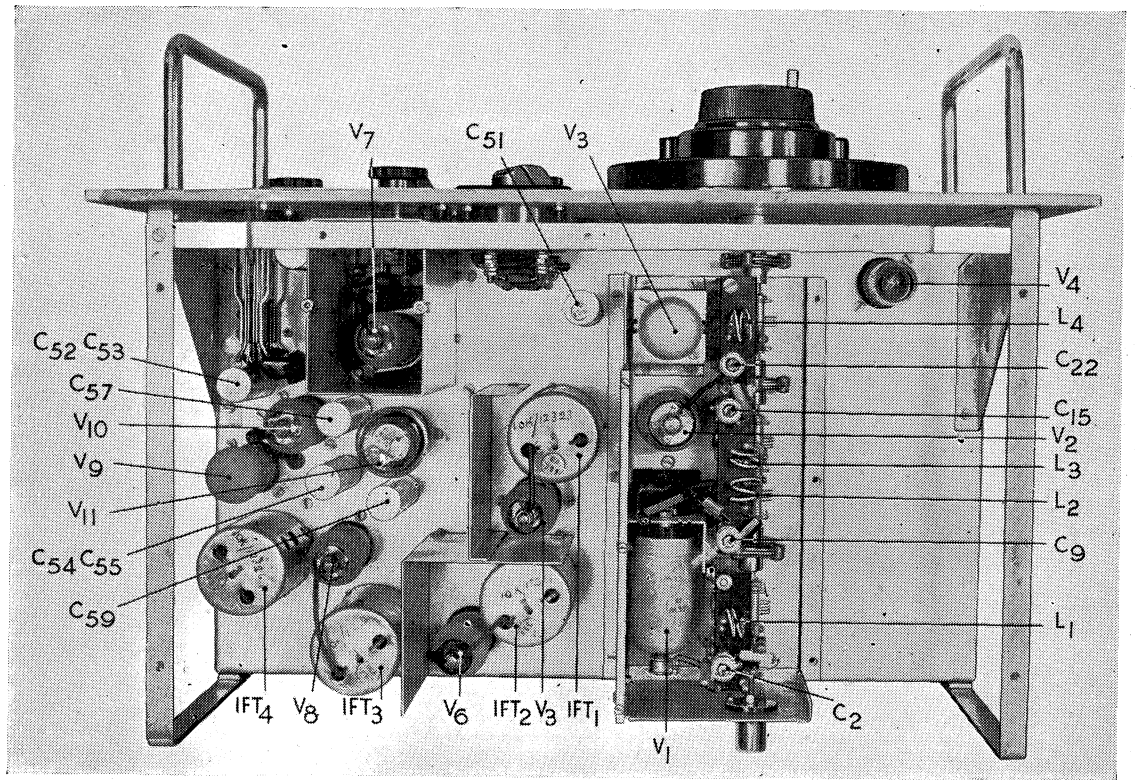

Fig. 6.—Interior view, showing valves

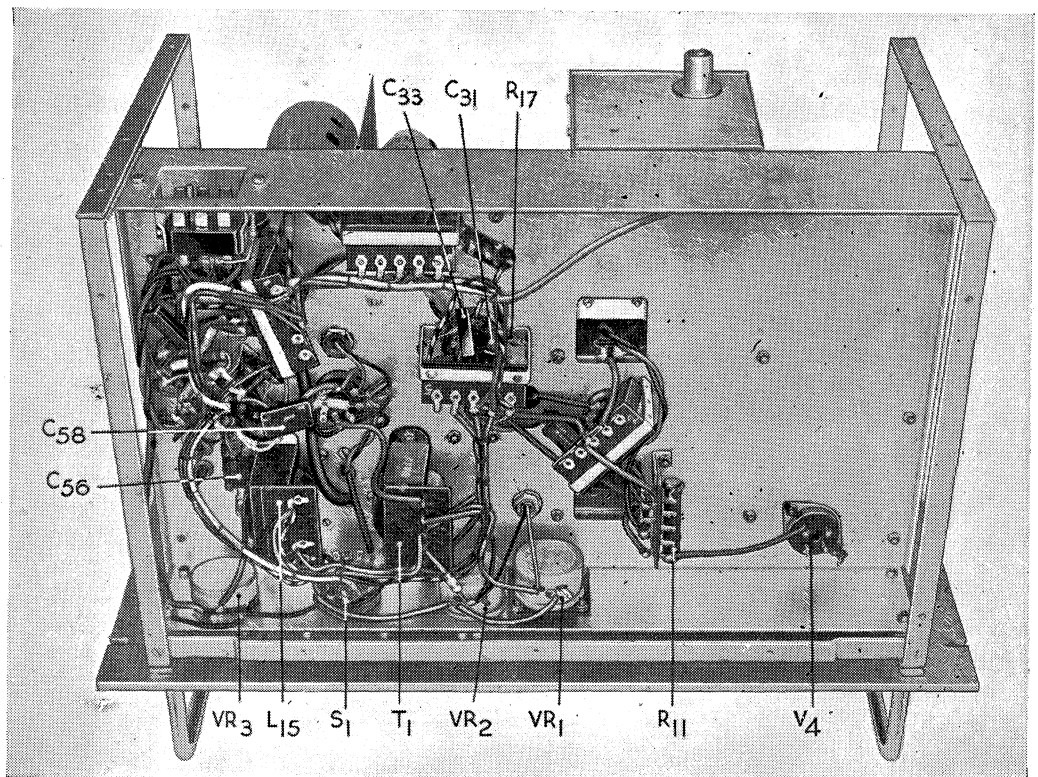

Fig. 7.—Underside view of chassis

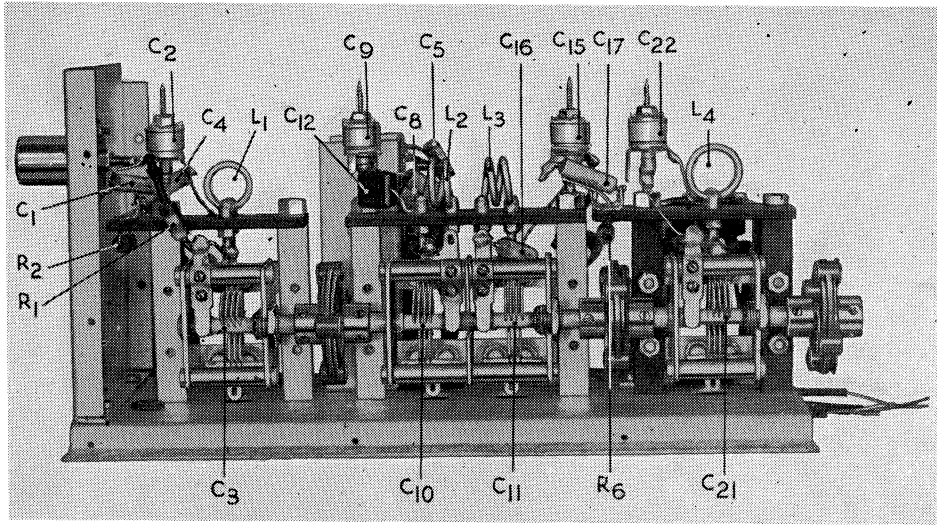

Fig. 8.—R/F unit, cover removed

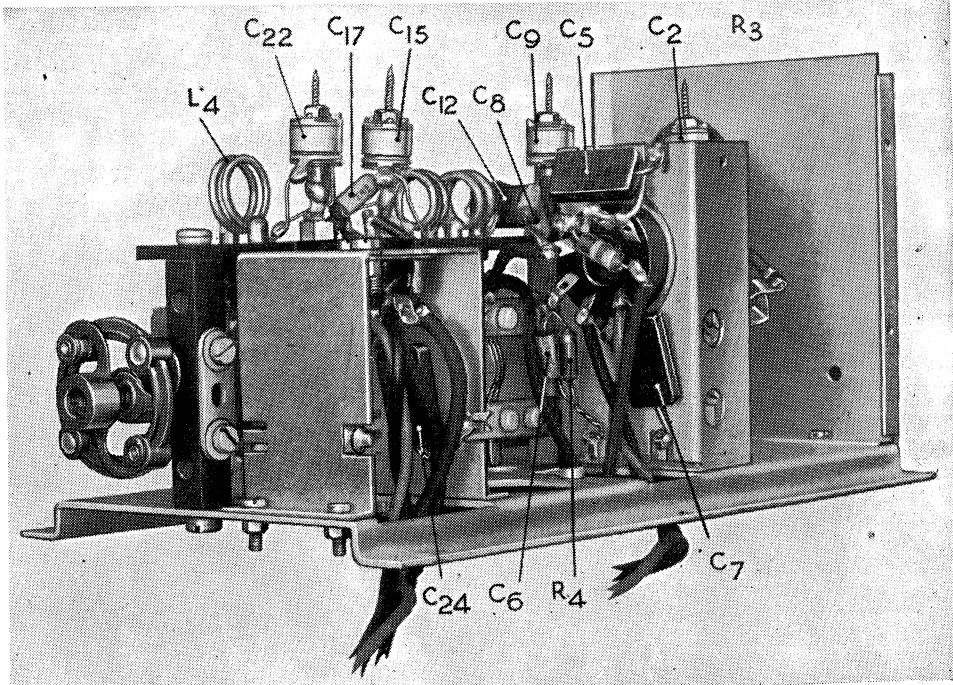

Fig. 9.—R/F unit, rear view

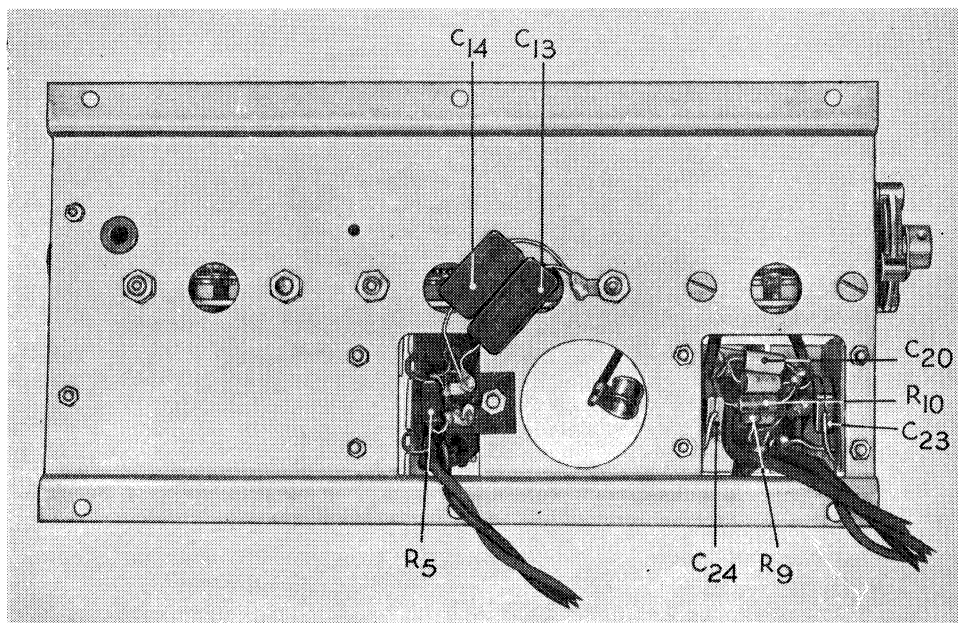

Fig. 10.—R/F unit, underside view

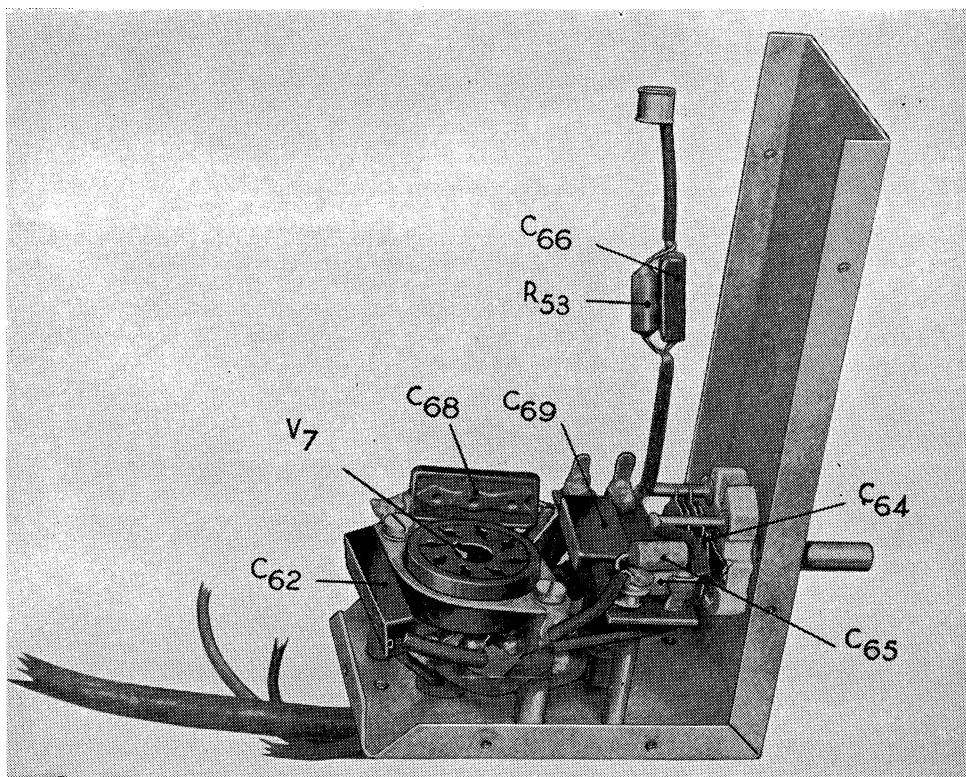

Fig. 11.—Beat frequency oscillator, interior view

are readily accessible for servicing, and may be located by referring to the bench wiring diagrams, fig. 3 and 4. Some of the components associated with the valves V_2 , V_5 , V_6 and V_8 have been mounted upon earthing bridges in order to facilitate construction and give better decoupling. A bench wiring diagram of the various earthing bridges is given in fig. (5).

21. A view of the control panel is shown in fig. 1. On the left of the panel may be seen the tuning control (1). This control drives the four ganged tuning condensers. The slow-motion-drive incorporates reduction gearing of special anti-backlash design, and the position of the condensers is indicated by a pointer moving over a calibrated dial. Frequencies corresponding to various dial settings are given on a calibration card which is mounted in a holder (2) on the right of the panel.

22. Immediately underneath the tone frequency control C_{64} is the A.G.C. switch S_1 . It has three positions, engraved respectively AUTOMATIC GAIN CONTROL, MANUAL GAIN CONTROL and TONE & MAN GAIN CONTROL. Two of these positions give the operator a choice of manual or automatic gain control, and the third brings the beat frequency oscillator into circuit.

23. On the left of the A.G.C. switch may be seen the R/F GAIN control VR_2 . It consists of a variable resistance in the cathode return leads of the I/F amplifier valves.

24. The tuning meter M_1 , measures the H.T. supply to the anode circuit of the first I/F amplifier valve. In addition to its normal function of indicating the correct tuning position, the meter also serves as a useful aid in forming an estimate of signal strength, since it shows the amount by which the anode current decreases due to A.G.C. action. The meter, of course, only functions as such, when the A.G.C. switch is set to the AUTOMATIC GAIN CONTROL position.

25. The attenuator control S_2 is a three-position switch which gives different power outputs. It varies the connections to a resistance network in the output stage of the receiver.

26. The tone frequency control C_{64} is located on the right of the attenuator. It consists of a variable condenser which is connected across the tuned circuit of the beat frequency oscillator valve.

27. The A/F gain control VR_3 is situated near the bottom right-hand corner of the panel. It consists of a carbon track type potentiometer which is connected in the output circuit of the diode detector, in order to regulate the output from the second detector to the A/F amplifier stages of the receiver.

28. A view of the upper section of the receiver is given in fig. 6. The annotations correspond to those on the theoretical circuit diagram, and the covers of the R/F tuning unit and the B.F.O. have been removed in order to show the position of the various valves. Most of the feed resistances and decoupling condensers are mounted on the underside of the chassis, which is illustrated in fig. 7. The tuning circuit is constructed as a separate assembly, and three views are given in fig. 8, 9, and 10. The B.F.O. is contained in a screened compartment, an interior view of which may be seen in fig. 11.

VALVES AND POWER SUPPLY

29. All the valves in the R.1132A are indirectly heated, and the total heater consumption is 3.5 amps. at 6.3volts. The pre-selector valve V_1 is a R/F pentode, type CV1065. The frequency changer V_2 is also a CV1065, and the triode oscillator V_3 is valve, type CV1066. The three I/F amplifier valves V_5 , V_6 and V_8 , and the beat frequency oscillator V_7 are all type CV1053. For signal and A.G.C. rectification a valve, type CV1054 is used. The variable gain A/F amplifier valve V_{10} is type V.R.57 and the triode valve V_{11} is type V.R.67.

30. Normally the receiver functions from a.c. supply mains in conjunction with the power unit, type 3, which requires an input of 190 to 250 volts 50 c/s. It consists essentially of a transformer, a full wave valve rectifier, and smoothing components and will be described elsewhere in this publication as well as in A.P.1186A. A voltmeter and milliammeter are mounted on the panel to indicate the voltage and current delivered by the power unit. For emergency operation, the receiver may be operated from a six-volt accumulator using the power unit, type 4, which incorporates a rotary transformer. The connections between the receiver and the power unit are made by means of a six contact plug and socket, the plug half being built into the receiver.

INSTALLATION

31. The receiver is carefully aligned before delivery, in conjunction with the set of valves with which it is intended to be used. The receiver should therefore be in perfect working order on arrival. Nevertheless, it is advisable to remove the dust cover in order to make a general inspection and ensure that the instrument is mechanically sound and that the valves are seating firmly in their sockets.

32. It is very important that components such as tuning coils and trimmers should not be touched. In particular the small two-turn and three-turn coils in the tuning unit are very critically adjusted. They may appear to be of distorted shape, but this is quite in order and is part of the initial adjustment. After checking on these lines the dust cover and screws should be replaced and the receiver mounted in the position provided on the rack.

OPERATION

33. After the receiver has been mounted on the rack, it should be connected up by inserting the six-contact socket from the power supply and output line, into the plug at the rear of the instrument. Then insert the aerial plug into the aerial socket. Switch on the power by means of the switch on the power unit. The small red pilot lamp should light immediately. The voltmeter will read 290 volts for a few seconds, and then drop to approximately 210 volts when the cathodes of the valves in the receiver reach their proper operating temperature. Similarly, the milliammeter on the power unit will show 10 mA for a few seconds, and then rise to approximately 50 mA.

34. Six tappings are provided on the primary winding of the mains transformer. A tapping appropriate to the voltage of the supply mains may be selected by means of a six-position switch on the panel of the power unit. This switch should be set in such a position that the voltmeter reads 210 volts when the receiver is connected.

35. Insert the telephone plug into the jack engraved MONITOR. Set the attenuator to the "—6" position and put the A.G.C. switch on AUTOMATIC GAIN CONTROL. Then set the L/F GAIN control so that the pointer is about vertical. Refer to the calibration chart on the receiver panel. From this the approximate dial setting for the desired signal may be obtained. If it is desired to tune the receiver to a frequency not shown on the chart, the approximate dial setting may be obtained by interpolation. Put the tuning pointer in this position, and if a signal is present the optimum setting can be determined by rocking the condenser until maximum dip is observed in the tuning meter.

36. If no external signal is available, the receiver may be tuned by means of a crystal monitor, type 4. First ensure that the correct crystal is in position, and tune the monitor to the desired frequency. The receiver may then be tuned in the manner described in the previous paragraph. After tuning, the crystal monitor must be switched off.

37. The tuning position will vary slightly whilst the receiver is warming up; apart from this it will function normally, but before the final adjustments are made, it is essential to allow the instrument to warm up for at least ten minutes and preferably half an hour. No further tuning should then be necessary for at least a day. It is preferable to do the final tuning on a signal which is neither too strong nor too weak. A signal giving a tuning meter reading of between 2.5 and 3.3 mA will be found most suitable.

38. The tuning meter is intended primarily to facilitate accurate tuning, but it has another important function in that it indicates the strength of an incoming signal. A strong signal produces a large reduction in reading, whilst a weak signal causes only a small reduction. The table below indicates the approximate values of signal strength for various meter readings.

<i>Signal strength (microvolts)</i>	<i>Millamps on tuning meter</i>
Zero	4.7
20	4.5
100	3.4
1,000	2.9
10,000	2.0
100,000	1.4

39. When the gain control switch is in the AUTOMATIC GAIN CONTROL position, the L/F GAIN control should not be set to more than $\frac{3}{4}$ of its maximum position, otherwise distortion will result. The ATTENUATOR should normally be set in the "—6" position, but if the output volume is still insufficient with the L/F GAIN control set to $\frac{3}{4}$ of its maximum, then the ATTENUATOR should be moved to the "O" position. Conversely, if too much volume is obtained on the "—6" position the ATTENUATOR should be moved to the "—12" position. If the correct combination of attenuator and L/F GAIN control is used, discomfort and fatigue due to noises from ignition interference etc. will be avoided.

40. For communication work the gain control switch should always be left in the AUTOMATIC GAIN CONTROL position. The R/F GAIN and TONE FREQUENCY controls are thus switched out of circuit, and the only controls used are TUNING, L/F GAIN, and ATTENUATOR.

41. When the receiver is being used for direction finding purposes it should first be tuned in accordance with the instructions given above. The A.G.C. switch should then be put in the MANUAL GAIN CONTROL position and the ATTENUATOR set to "−6db." The L/F GAIN control should be set to maximum and the signal should then be reduced to a comfortable level by means of the R/F GAIN control. In order to avoid overloading and give a sharp minimum, it is very important to work at a low signal level by reducing the setting of the R/F GAIN control as much as possible. If the bearing is being taken on an unmodulated carrier, the instrument should be tuned in normally, using the tuning meter. The A.G.C. switch should then be put in the TONE AND MANUAL GAIN CONTROL position and the TONE FREQUENCY CONTROL adjusted until an audible note is heard in the telephone. Slight re-adjustment of the frequency may be necessary to retain an audible note, but after the receiver has warmed up, the beat note should remain audible for at least two minutes. This gives ample time to take a bearing.

42. If the signal is too weak to operate the tuning meter, put the A.G.C. switch in the AUTOMATIC GAIN CONTROL position and tune in the receiver using the signal from the crystal monitor or the ground transmitter. Then switch off the crystal monitor or ground transmitter, put the A.G.C. switch in the TONE AND MANUAL GAIN position, and search for the signal with the TONE FREQUENCY CONTROL.

PRECAUTIONS

43. The alignment of the tuned circuits constitutes the most intricate part in the maintenance of the R.1132A. It should only be undertaken by competent personnel equipped with adequate test apparatus, which should include a signal generator and an output meter.

44. If a faulty valve is suspected, the receiver should be switched on for a few minutes in order to allow time for warming up. A valve with a broken or open circuited heater will feel cold when touched.

45. New valves may be fitted in the audio stages without involving any changes in the adjustment of the receiver. Since valves of a similar type seldom have exactly similar characteristics, the fitting of a new valve in one of the earlier stages may necessitate the re-alignment of the associated tuned circuits.

46. In general, however, it will be found that in the case of the valves in the I/F amplifier and beat frequency oscillator stages, V_5 , V_6 , V_8 and V_9 , no re-alignment will be necessary. The most critical stages are those associated with the signal frequency R/F amplifier V_1 , the frequency changer V_2 and the oscillator V_3 . If V_1 is replaced, C_2 and C_9 may have to be re-adjusted. In the case of V_2 , C_{15} may have to be adjusted and also the permeability tuning of the primary section L_5 of the first I/F amplifier. If a new oscillator valve is fitted, complete re-alignment of the signal frequency section of the receiver may be necessary.

47. It may be found that, even though the receiver checks satisfactorily on all static tests the receiver is insufficiently sensitive or no signal can be obtained. If the changing of valves does not produce an improvement it is probable that one or other of the decoupling condensers is faulty on the frequencies for which the receiver has been designed, or that a high resistance contact has developed at one of the earthing points. A condenser which appears to be loose on its lead-out wires should be replaced.

48. If the receiver is alive when the monitor is plugged in the line jack but becomes dead when the monitor is plugged into the monitor jack, then the outgoing line from the plug at the rear of the receiver is short-circuited.

ALIGNMENT

I/F alignment

49. The receiver and the signal generator, type 12 (10 SB/17), should be switched on ten minutes before the commencement of alignment, which should start at the fourth I/F transformer (stage before 2nd Det.), working back stage by stage to the first I/F stage. After ten minutes:—

- (i) First, set up the signal generator to 12 Mc/s from the chart and inject a modulated signal between the grid of V_2 and the chassis. Rock the tuning of the signal generator slightly to obtain the actual I/F point (11.5—12.5 Mc/s). Then inject at this frequency between the grid of V_8 (third I/F) and the chassis; a capacity of $0.01 \mu\text{F}$ should be introduced into the signal generator lead to the grid. Turn the switch to A.G.C.; adjust the I/F gain to maximum; set the attenuator to zero. An input of 100 millivolts should give a reading of at least 1 volt on an avometer connected directly across the output. Adjust the iron

dust core of T_4 through the upper hole in the can, for maximum output, using an insulated screwdriver or tuning tool 10A/13505. Similarly adjust the other iron dust core through the lower hole in the can. Note the reading on the avometer, which will vary with different receivers.

- (ii) Next, inject the input between the grid of the previous (second I/F) valve V_6 and the chassis. Reduce the input voltage to 10 mV and adjust the iron dust cores of T_3 for maximum output. A reading of at least the same figure as that obtained when T_4 was adjusted should be obtained with the reduced input showing a gain of at least ten times. Transfer the input to the preceding stage between the grid of V_5 and chassis, and reduce the input voltage ten times to 1 mV, adjusting the iron dust cores of $I/F T_2$ for maximum output. A gain of at least ten times should be obtained for this stage also.
- (iii) Finally, with the input reduced to 100 microvolts and connected between the grid of V_2 (frequency changer) and the chassis adjust the iron dust cores of T_1 . The gain at this stage may fall a little short of ten times, owing to the effect of the resistances shunted across the primary and secondary of T_1 . There is considerable risk of instability at this stage and care should be taken to see that the lead from the signal generator does not pass close to the subsequent I/F stages.
- (iv) To check the overall I/F sensitivity, swing the main frequency control of the signal generator each side of the actual I/F, and reduce the input till a dip of half a division is obtained on the tuning meter of the receiver when passing through resonance. The input required should not be in excess of 80 microvolts; if it is, a definite fault exists in the I/F stages.

BFO alignment

50. After I/F alignment, a 200 microvolt unmodulated signal at the resonant I/F should be injected between the grid of V_2 and the chassis. Switch to TONE AND MANUAL GAIN; set the tone frequency control to its mid-position, and R/F and I/F gain to maximum. The iron dust core inside the BFO should then be adjusted to zero beat, preferably using a non-metallic screwdriver. If using a longhanded insulated screwdriver, the proximity of the screwdriver to the grid of V_7 may affect considerably the position of the tone frequency control condenser, so adjust in steps, removing the screwdriver before testing the effect. It is important to ensure that the zero beat is not adjusted on a spurious signal. This can be ascertained by swinging the condenser through its range and observing the strength of the beat notes. At the correct point, a beat note considerably stronger than any other will occur.

Signal frequency alignment

51. Remove the screening cover of the R/F unit and refix two screws to secure the sub-chassis. Connect the signal generator to the aerial plug of the receiver and tune it and the receiver to 124 Mc/s. Remove the fixing dope from the four concentric trimming condensers.

- (i) Using the tuning tool, Stores Ref. No. 10A/13505, adjust the condensers to "peak" starting with the one nearest the front (C2) panel, and working back through C9, C15, C22 in that order.
- (ii) With signal generator and receiver set to 100 M/cs, adjust the silvered coils L1, L2, L3, L4 in that order, to peak, using the tuning tool, Stores Ref. No. 10A/13506.
- (iii) Repeat (i) at 124 Mc/s.
- (iv) Repeat (ii).
- (v) Alternate (iii) and (iv) until further adjustments are very slight.
- (vi) Replace the screening cover, check again at 124 Mc/s, and re-seal the trimming condensers.

52. The values of input required with the switch on A.G.C., L.F. gain at maximum, and attenuator at zero, to obtain a dip in the tuning meter reading of about half a division, are approximately as follows (dummy aerial fed through .01 mfd):—

	At aerial		At grid of V_1		At grid of V_2	
Mc/s	124	100	124	100	124	100
μ V	20	25	30	35	50	60

53. It will not be necessary to adjust the oscillator trimmer C_{22} , unless renewal of the oscillator valve causes an appreciable difference in calibration as shown on the chart attached to the receiver. Recalibration can be effected by adjusting the trimmer condenser at the higher frequencies and the inductance L_4 at the lower frequencies, or by slackening the grub screw holding the drive and re-setting the pointer if the variation from the scale reading is constant throughout the frequency range.

TABLE I

FAULT-FINDING CHART

54.

System	Probable fault	Test
(a) No signals and no background noise	(i) Power unit faulty	Test power unit
	(ii) Breeze connectors faulty	Test connectors
	(iii) Output line short circuited	Plug phones into MONITOR jacks. If signals are heard output line is at fault
	(iv) Output valve V_{11} (VR67) faulty	Touch grid connection; if no clicks or hum are heard change the valve
	(v) Octode valve V_{10} (CV1057) faulty	(a) Touch grid connection; if no clicks or hum are heard change the valve (b) Test valve voltages. These should be:—anode 60V to 70V; screen 52V; cathode bias 3V
(b) No signals, but adequate background noise	(i) Detector circuit faulty	Switch to "A.G.C." obtain a signal from crystal monitor, type 4 and tune to see whether a "dip" is observed in the tuning meter (a) If a dip is observed, the detector circuit may be faulty. Test by injecting a 12 Mc/s modulated signal to the detecting anode of the diode V_9 . If no signals are then heard in the phones, try changing the diode; testing the volume control; changing the coupling condenser to the A.F. valve; testing the I.F. transformer T_4 for an open circuit. If the detector stage is satisfactory, test the A.F. circuits as in 5 (v) (b) If no dip is observed proceed with (ii), (iii) or (iv)
	(ii) I.F. circuits faulty	Switch to "A.G.C." and inject a 12 Mc/s signal to the control grid of the third I.F. amplifier valve V_8 . (a) If no dip is observed at the tuning meter check the valve voltages (anode 200, screen 55 and 65, cathode 1.7 to 2.5); try changing the valve, test the I.F. transformer T_3 and test the circuits for dry joints and disconnections (b) If a dip is observed, repeat, injecting the signal at the grid of V_7 (the appropriate voltages are:—anode 200, screen 75, cathode 2 to 2.5) (c) If a dip is observed in (b), repeat with V_6 . The voltages should be:—anode 200, screen 80, cathode 2 to 3 (d) If a dip is observed in test (c) try (iii)
	(iii) Mixer circuit faulty	Inject a V.H.F. signal at the grid of the mixer valve V_2 . If no signals are obtained, change the valve, and inspect its circuits. If this is unsuccessful, try changing the oscillator valve V_3 and inspecting its circuits. Inject a V.H.F. signal to the grid of the valve V_1 (a) If no signals are obtained, change the valve and test its circuits (b) If no signals are obtained, test the aerial input circuit which must be at fault if all other tests have given negative results
(c) Weak signals	(i) Power unit faulty	Test as described elsewhere
	(ii) Faulty valve or valve circuit	Proceed as in (2)
	(iii) Faulty bias decoupling condenser in A.F. stages	Try renewal
	(iv) Faulty resistors	Test resistances
	(v) Misalignment of tuned circuits	Realign

FAULT-FINDING CHART—(contd.)

System	Probable fault	Test
(d) Excessive back-ground noise	(i) Local interference	See whether noise disappears when signal is obtained from signal generator
	(ii) Dirty switches	Clean contacts with carbon tetrachloride
	(iii) Microphonic valves	Tap each in turn, gently. Renew any valve which gives excessive noise when tapped
	(iv) Dry joints in wiring	
	(v) Components loose	
	(vi) Loose or dirty Jones plugs	Inspect, and clean with carbon tetrachloride
(e) Instability and distortion	(i) Disconnected screws on rear stabilizer valves	Inspect
	(ii) Poor earthing	Inspect all earthing tags
	(iii) Open circuits in decoupling condensers	Try effect of parallel condensers
	(iv) Faulty A.V.C.	Check that meter dips with signal
	(v) A.F. stages faulty	Test A.F. valves and voltages, bias resistors (open circuit) and bias condensers

55. The voltages given in Table II are measured with a rectifier output of 210 volts, 50 mA and with the volume control at MAX. No signal input should be allowed.

TABLE II
VALVE VOLTAGES

Stage	Valve	Anode Volts	Screen Volts	Cathode Volts
V ₁	CV1065	190	200	1.5
V ₂	CV1065	200	115	2.5-3
V ₃	CV1066	100 (stabilized)		
V ₄	CV1070	NEON		
V ₅	CV1053	200	55-65	1.7-2.5
V ₆	CV1053	200	75	2 -2.5
V ₇	CV1053	125	—	—
(BFO)				
V ₈	CV1053	200	20	2 -3
V ₉	CV1054	DETECTOR		
V ₁₀	CV1057	60-70	52	3
V ₁₁	CV1067	208	—	6

Note.—Fig. 12 is on the back of this leaf

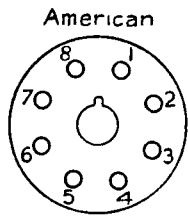

VALVE TYPE

- VR 53
- VR 54
- VR 57
- VR 67

T C = TOP CAP

View of underside of base

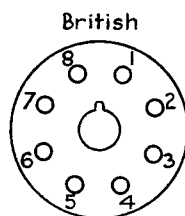

VALVE TYPE

- V. R. 65
- V. R. 66

T.C. = TOP CAP

View of underside of base

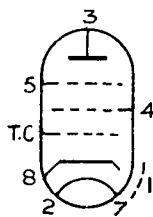

- 1 - Metallising
- 2 - Heater
- 3 - Anode
- 4 - Screen grid
- 5 - Suppressor grid
- 6 - Blank
- 7 - Heater
- 8 - Cathode
- T.C - Control grid

CV 1053

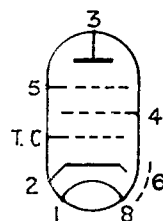

- 1 - Heater
- 2 - Cathode
- 3 - Anode
- 4 - Grid 2
- 5 - Grid 3
- 6 - Metallising
- 7 - Blank
- 8 - Heater
- T.C- Grid 1

CV 1065

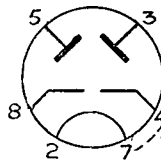

- 1 - Metallising
- 2 - Heater
- 3 - Anode 2
- 4 - Cathode 2
- 5 - Anode 1
- 6 - Blank
- 7 - Heater
- 8 - Cathode 1

CV 1054

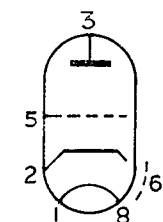

- 1 - Heater
- 2 - Cathode
- 3 - Anode
- 4 - Blank
- 5 - Grid
- 6 - Metallising
- 7 - Blank
- 8 - Heater

CV 1066

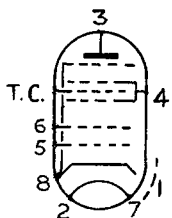

- 1 - Metallising
- 2 - Heater
- 3 - Anode
- 4 - Grids 3 and 5
- 5 - Grid 1
- 6 - Grid 2
- 7 - Heater
- 8 - Cathode and Grid 6
- T.C - Grid 4

CV 1057

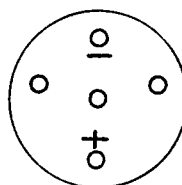

View of underside of base

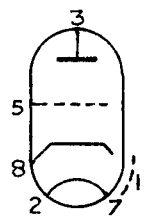

- 1 - Metallising
- 2 - Heater
- 3 - Anode
- 4 - Blank
- 5 - Screen grid
- 6 - Blank
- 7 - Heater
- 8 - Cathode

CV 1067

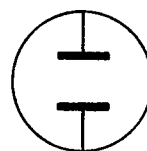

CV 1070

Fig. 12—VALVE HOLDER CONNECTIONS

APPENDIX I
NOMENCLATURE OF PARTS

The following list of parts is issued for information only. When ordering spares for this equipment the appropriate Section of AIR PUBLICATION 1086 must be used.

Ref. No.	Nomenclature	Qty.	Ref. in fig. 2	Remarks
10D/105	Receiver, Type R.1132A			For rack mounting
	Principal components:—			
10D/4	Card, calibration	1		
10C/2601	Choke L/F Type 90	1		Filter choke
	Condenser			
10C/5692	Type 3271	1	C ₅₀	2 $\mu\mu\text{F}$, ceramic tube
10C/2079	Type 969	1	C ₄₉	50 $\mu\mu\text{F}$, ceramic tube
10C/219	Type 624	2	C ₅₆	0.002 μF , micamoulded
10C/11138	Type 3374	20		0.01 μF paper tubular
20C/2083	Type 973	1	C ₅₂ , C ₅₃	0.05 + 0.05 μF , paper
10C/2084	Type 974	2	C ₅₄ , C ₆₀ , C ₆₁	0.1 + 0.1 μF paper, aluminium cylinder
10C/3401	Type 1664	2	C ₅₇ , C ₅₉	0.5 μF paper, aluminium cylinder
10C/2599	Type 1229	1	C ₅₁	25 μF , 50V dry electrolytic
10C/3774 or 10C/12324	Type 1907 or 3870	1	C ₇₂	500 $\mu\mu\text{F}$
10C/14446	Type 4781	1	C ₇₃	0.5 μF
10A/11821	Cover, Type 6	1		
10A/11822	Drive, slow motion, Type 5	1		
10D/7	Escutcheon, moulded	1		
	Holder, valve			
10H/491	Type 72	1		British octal
10H/493	Type 73	6		American octal
10H/499	Type 75	1		4-pin
10H/1923	Type 155	1		Diode
10H/1739	Jack, Type 1	2	J ₁ , J ₂	Telephone
	Knob			
10A/11824	Type 7	1		Slipping clutch
10A/11836	Type 8	2		Instrument pointer type
10A/12768	Type 72	3		Fluted with stop lever
10A/11000	Milliammeter, 0 to 5, Type B	1	M ₁	2 in. dial
10V/30	Oscillator unit, Type 24 fitted with Condenser	1		Complete beat oscillator
10C/3397	Type 1661	1	C ₆₅	80 $\mu\mu\text{F}$
10C/2076	Type 966	1	C ₆₆	0.0003 μF , mica
10C/11138	Type 3374	3	C ₆₇ , C ₆₈ , C ₆₉	0.01 μF , paper
10C/2082	Type 972	1	C ₆₄	2 to 6.5 $\mu\mu\text{F}$, air vari- able pitch control
	Resistance			
10W/542	Type 808	1	R ₅₄	22,000 ohms
10W/546	Type 809	1	R ₅₃	47,000 ohms
10W/11499	Type 487	1	R ₅₅	100,000 ohms
10H/493	Valveholder, Type 73	1		American octal
10H/301	Plug, screwed	1		To cover pre-set spindle
10H/426	Plug, Type 206	1		6-pole supply plug
	Resistance			
10W/1342	Type 1342	3	R ₁₄ , R ₂₂ , R ₂₅	220 ohms $\frac{1}{4}$ watt
10W/1903	Type 1903		R _{14A} , R ₂₂ , R _{25A}	100 ohms
10W/1108	Type 1108	1	R ₈	620 ohms
10W/11667	Type 500	2	R ₄₁ , R ₄₃	1,000 ohms
10W/691	Type 875	4	R ₅ , R ₁₂ , R ₂₁ , R ₃₁	2,200 ohms $\frac{1}{4}$ watt
10W/948	Type 975	1	R ₄₄	4,700 ohms $\frac{1}{4}$ watt
10W/11623	Type 490	1	R ₁₁	10,000 ohms 2 watt
10W/546	Type 809	1	R ₂₈	47,000 ohms $\frac{1}{4}$ watt
10W/1076	Type 1076	3	R ₃₉ , R ₂₇ , R ₂₀	68,000 ohms $\frac{1}{4}$ watt
10W/1399	Type 1399	3	R ₁₇ , R ₃₄ , R ₂₃	220,000 ohms
10W/11499	Type 487	5	R ₁₈ , R ₃₃ , R ₃₈ , R ₄₀ , R ₇	100,000 ohms $\frac{1}{4}$ watt

Ref. No.	Nomenclature	Qty.	Ref. in fig. 2	Remarks
10W/1476	Type 1476	8	R ₁₅ , R ₂₄ , R ₂₆ , R ₃₂ , R ₃₅ , R ₃₆ , R ₃₇ , R ₄₂	330,000 ohms
10W/1567	Type 1567	1	V.R. ₁	100 ohms potentiometer slider earthed to case
10W/1568	Type 1568	1	V.R. ₂	2,000 ohms potentiometer slider earthed to case
10W/8715 or 10W/8998	Type 2177	1	V.R. ₃	500,000 ohms potentiometer $\frac{1}{2}$ watt
10D/231	Type 2374 Scale, tuning	1		
10F/316	Switch, Type 315	1	S ₁	1 wafer, 3-pole, 3-position
10F/450	Switch, Type 423 fitted with Panel, 3 in. \times 1 $\frac{3}{8}$ in.	1	S ₂	1 wafer, 4-pole, 3-position
10W/1342	Resistance, Type 1342	4	R ₄₉ , R ₅₀ , R ₅₁ , R ₅₂	220 ohms, $\frac{1}{4}$ watt
10W/691	Resistance, Type 875	4	R ₄₅ , R ₄₆ , R ₄₇ , R ₄₈	2,200 ohms $\frac{1}{4}$ watt
10K/176	Transformer, Type 289	1	T ₁	Output, C.T. secondary
10K/1949	Transformer unit, Type 99 fitted with	1	IFT ₁	1st I/F
10C/10552	Condenser, Type 421	2	C ₂₇ , C ₂₉	50 μ F, silvered mica
10C/546	Resistance, Type 809	2	R ₁₃ , R ₁₈	47,000 ohms, $\frac{1}{4}$ watt
10K/1950	Transformer unit, Type 100 fitted with	2	IFT ₂ , IFT ₃	2nd and 3rd I/F
10C/10552	Condenser, Type 421	2	C ₃₂ , C ₃₄ , C ₃₈ , C ₄₀	50 μ F, silvered mica
10K/1951	Transformer unit, Type 101 fitted with	1	IFT ₄	
10C/4922	Condenser, Type 2612	2	C ₄₄ , C ₄₆	30 μ F, silvered mica
10C/4324	Condenser, Type 2229	1	C ₄₇	50 μ F, moulded mica
10C/546	Resistance, Type 800	1	R ₂₉	17,000 ohms $\frac{1}{4}$ watt
10W/6842	Resistance, Type 6842			68,000 ohms $\frac{1}{2}$ watt
10W/6471	Resistance, Type 6471	1	R ₂₉ A	220,000 ohms $\frac{1}{2}$ watt
10D/230	Tuning unit, Type 36 fitted with Condenser			
10C/3219	Type 1573	2	C ₁ , C ₁₆	5 μ F, ceramic tube
10C/2073	Type 963	2	C ₄ , C ₁₇	10 μ F, ceramic tube
10C/2075	Type 965	1	C ₈	30 μ F, ceramic
10C/3397	Type 1661	2	C ₈ , C ₂₀	80 μ F
10C/2076	Type 966	1	C ₁₂	0.0003 μ F, mica
10C/4502	Type 2328	5	C ₆ , C ₇ , C ₁₄ , C ₂₃ , C ₂₄	0.001 μ F, mica
10C/11138	Type 3374	1	C ₁₃	0.01 μ F, moulded pape
10C/2069	Type 959	1	C ₃	3 to 18 μ F, aerial
10C/2070	Type 960	1	C ₂₁	3 to 20 μ F, oscillato
10C/2071	Type 961	1	C ₁₀ , C ₁₁	3 to 18 μ F, 2-gang
10C/2072	Type 962	4	C ₂ , C ₈ , C ₁₅ , C ₂₂	2 to 8 μ F, trimmer
10A/12380	Coupling, Type 5	3		Flexible, for tuning condenser
10H/491	Holder, valve, Type 72 Resistance	2		British octal
10W/1564	Type 1564	1	R ₄	150 ohms, $\frac{1}{4}$ watt
10W/691	Type 875	1	R ₅	2,200 ohms, $\frac{1}{4}$ watt
10W/948	Type 975	2	R ₁ , R ₃	4,700 ohms, $\frac{1}{4}$ watt
10W/1565	Type 1565	1	R ₁₀	18,000 ohms, $\frac{1}{4}$ watt
10W/546	Type 809	1	R ₉	47,000 ohms, $\frac{1}{4}$ watt
10W/11499	Type 48	2	R ₆ , R ₂	100,000 ohms, $\frac{1}{4}$ watt
10H/10330	Socket, Type 56 Accessories, Valve CV10	1		S.P. aerial socket
10CV/1053	Type CV10/53	4	V ₅ , V ₆ , V ₇ , V ₈	American octal
10CV/1054	Type CV10/54	1	V ₉	Double diode
10CV/1057	Type CV10/57	1	V ₁₀	A/F amplifier
10CV/1065	Type CV10/65	2	V ₁ , V ₂	British octal
10CV/466	Type CV10/66	1	V ₃	Triode
10CV/1067	Type CV10/67	1	V ₁₁	Output. American octal
10CV/1070	Type CV10/70	1	V ₄	Neon stabilizer
10CV/1092	Type CV10/92	1	V ₁₂	Diode

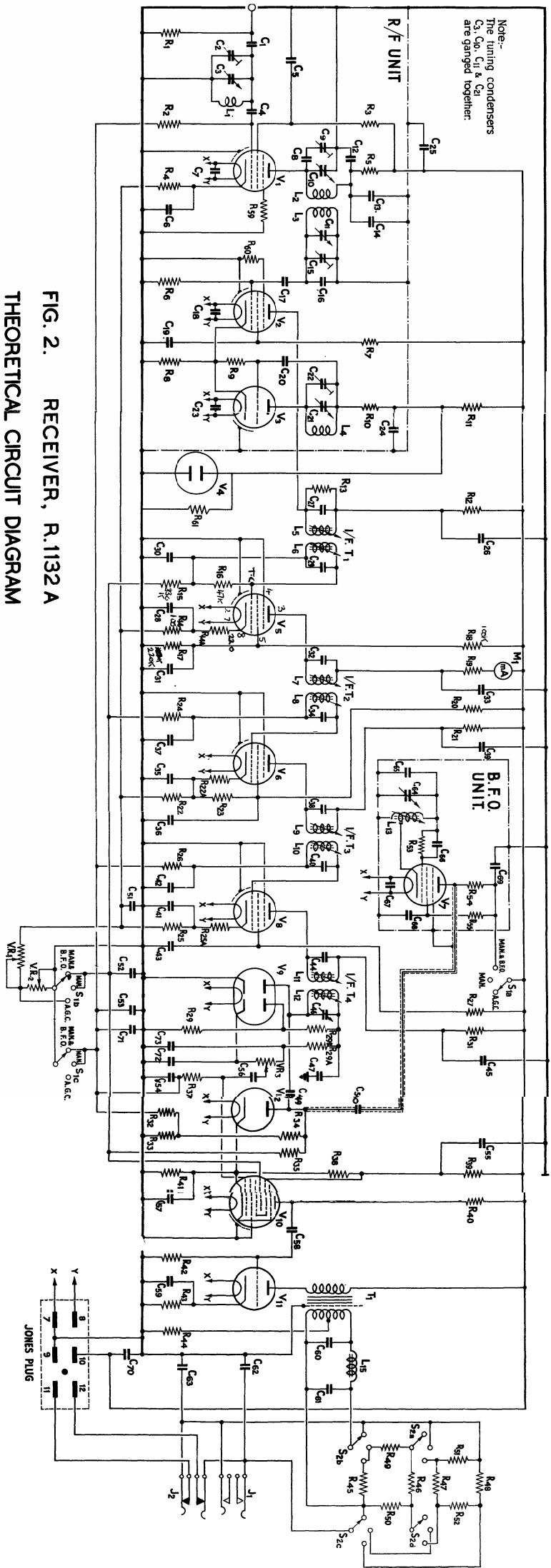

FIG. 2. RECEIVER, R.1132A
THEORETICAL CIRCUIT DIAGRAM

Chapter 2

RECEIVER R.1481

LIST OF CONTENTS

	<i>Para.</i>
<i>Introduction</i>	1
<i>Circuit description</i>	3
<i>List of components</i>	Appendix

LIST OF ILLUSTRATIONS

	<i>Fig.</i>
<i>R.1481—circuit</i>	1
<i>Bench wiring diagram (underside of chassis)</i> ...	2

INTRODUCTION

1. The receiver, Type R.1481, is a modified form of the receiver, Type R.1132A, described in Chap. 1. The principal difference between the two lies in the frequency range which is 65 Mc/s to 85 Mc/s for R.1481. This is obtained by the substitution of a tuning unit, Type 164, in place of the Type 36 used in R.1132A. The tuning units differ only in the coils L1, L2, L3, and in the removal of "C16" of R.1132A, and in the addition of C72.

2. The second difference lies in the second detector circuit; in this respect R.1481 is identical with the version of R.1132A existing before the "Modification for Suppression of Pulse Interference" (Mod. No. 472/1) was made to R.1132A; leaflet A.P.1186A/B.5 refers.

CIRCUIT DESCRIPTION

3. Para. 1 to 15 of Chapter 1 apply to R.1481 as much as to R.1132A, and will not be repeated here. The following paragraph, however, takes the place of *para.* 16 in Chapter 1 as it describes the unmodified detector circuit.

4. Diode detection is used, and the AF output is filtered by R29, C47 and C48. The output developed across the diode load resistors R28, R30 and VR3 is fed to the grid

of the first AF amplifier valve V10 via the slider of the audio gain control VR3 and the condenser C56. The detector valve V9 contains two separate diodes in one envelope. The first diode is the signal diode or second detector, and the second diode provides the AGC bias. The AGC voltage is fed back to the grids of V1, V5, V6 and V10, thus regulating both the RF and the AF gain of the receiver. In order to ensure that the AGC will not come into operation on a weak signal, the cathode of the second diode is provided with a positive delay voltage of 2.5 to 3 volts by the potential divider R39, R38 and R41.

5. Para. 17 to 55 of Chap. 1 again apply to R.1481 as much as to R.1132A, the only difference being that in *para.* 51 (signal frequency alignment) and in *para.* 52 "85 Mc/s" should be read instead of "124 Mc/s" as applying to R.1481, and "65 Mc/s" instead of "100 Mc/s".

6. The location of components and wiring of R.1481 is shown in *fig.* 1 and 6 to 12 inclusive, of Chap. 1; *fig.* 3 (wiring of topside of chassis) also applies except that the condenser C72 (bottom left-hand corner) does not appear in R.1481, nor does C16 in the RF unit. The new condenser C72 fitted in R.1481 in parallel with R4 is not shown. *Fig.* 4 of Chap. 1 does not apply to R.1481; *fig.* 2 of this chapter supersedes it. *Fig.* 5 of Chap. 1 applies except that the resistors R56, R57, R58 of R.1481 appear as R14A, R22A and R25A respectively

KEY TO FIG. 1

This gives resistance and condenser values in thousands of ohms and micro-microfarads, except where M follows the number, indicating microfarads.

C1	C2	C3	C4	C5	C6	C7	C8	C9	C10	C11	C12	C13	C14	C15
5	2-8	3-18	10	1000	30	1000	80	2-8	3-18	3-18	300	.01M	1000	2-8
C16	C17	C18	C19	C20	C21	C22	C23	C24	C25	C26	C27	C28	C29	C30
—	10	.01M	.01M	80	3-20	2-8	1000	1000	.01M	.01M	50	.01M	50	.01M
C31	C32	C33	C34	C35	C36	C37	C38	C39	C40	C41	C42	C43	C44	C45
.01M	50	.01M	50	.01M	.01M	.01M	50	.01M	50	.01M	.01M	.01M	30	.01M
C46	C47	C48	C49	C50	C51	C52	C53	C54	C55	C56	C57	C58	C59	C60
30	50	—	50	2	25M	.05M	.05M	.1M	.1M	2000	.5M	2000	.5M	.1M
C61	C62	C63	C64	C65	C66	C67	C68	C69	C70	C71	C72			
.1M	.01M	.01M	1-5	80	300	.01M	.01M	.01M	.01M	.01M	100			
R1	R2	R3	R4	R5	R6	R7	R8	R9	R10	R11	R12	R13	R14	
4-7	100	4-7	.16	2-2	100	100	.62	47	18	10	2-2	4-7	.1	
R15	R16	R17	R18	R19	R20	R21	R22	R23	R24	R25	R26	R27		
330	47	220	100	2-2	68	2-2	.1	220	330	.1	330	68		
R28	R29	R30	R31	R32	R33	R34	R35	R36	R37	R38	R39	R40		
47	47	47	2-2	330	100	220	330	330	330	100	68	150		
R41	R42	R43	R44	R45	R46	R47	R48	R49	R50	R51	R52	R53	R54	R55
1	330	1	4-7	2-2	2-2	2-2	2-2	.22	.22	.22	.22	47	22	100
R56	R57	R58	R59	R60	R61	VR1	VR2	VR3						
.22	.22	.22	.047	.047	47	.1	.2	60						

Appendix

LIST OF COMPONENTS

This list of parts was correct at the date of issue, but may not be kept up to date. Before ordering spares, reference should be made to A.P.1086, or to Vol. III of this publication when available.

<i>Ref. No.</i>	<i>Nomenclature</i>	<i>Ref. in Fig. 1</i>	<i>Description</i>
10B/1562	Receiver, Type R.1481		Rack mounting assembly, 19 in. \times 10 $\frac{1}{2}$ in. \times $\frac{1}{8}$ in. panel. R.1132A modified for 65–85 Mc/s with valves.
	Includes:—		
10A/14866	Brackets, Type 194		M.S. nickel plated.
10A/14604	Bushes, Type 56		Moulded 1.25 in. dia. \times 0.531 in. Shoulder 0.630 O/D \times 0.437 in. I/D.
5E/2232	Cable, electric, H.F. Uniradio No. 32		Coaxial, polythene insulation.
10A/13025	Caps, valve, Type 13		Top cap clip with semi-circular spring.
10D/4	Cards, calibration		3 $\frac{1}{8}$ in. \times 2 $\frac{13}{16}$ in.
10C/2601	Chokes, L.F., Type 90	L15	Open 2 $\frac{1}{2}$ in. \times 1 $\frac{3}{4}$ in. \times 2 in. with tag panel. Black varnish impregnated, tropical.
	Condensers:—		
10C/5962	Type 3271	C50	2 $\mu\mu\text{F.}$, \pm 0.5 $\mu\mu\text{F.}$, 500 volts DC working. Ceramic tube, and wires, negative coefficient.
10C/2079	Type 969	C49	50 $\mu\mu\text{F.}$, \pm 0.25 $\mu\mu\text{F.}$. Ceramic tube, end wires, negative coefficient.
		<i>or</i>	
10C/14880	Type 5007		50 $\mu\mu\text{F.}$, \pm 2 per cent 500 volts DC working. Ceramic.
10C/24	Type 580	C58	2,000 $\mu\mu\text{F.}$, \pm 15 per cent, 350 volts DC working. Moulded, mica, end wires.
10C/219	Type 624	C56	2,000 $\mu\mu\text{F.}$, \pm 5 per cent, 350 volts DC working. Moulded, mica, tags.
10C/11138	Type 3374	C25–6, 28, 30–1, 33, 35–7, 39, 41–3, 45, 63, 70–1	0.01 $\mu\text{F.}$, \pm 20 per cent, 375 volts DC working. Paper, tubular, end wires.
10C/9755	Type 332	C62	0.01 $\mu\text{F.}$, \pm 20 per cent, 375 volts DC working. Paper, tubular.
10C/2083	Type 973	C52–3	0.05 + 0.05 $\mu\text{F.}$, \pm 15 per cent, 350 volts DC working. Paper, aluminium tube $\frac{3}{4}$ in. dia. \times 2 $\frac{11}{16}$ in., insulated, tropical.
10C/2084	Type 974	C54–5, 60–1	0.1 + 0.1 $\mu\text{F.}$, \pm 10 per cent, 350 volts DC working. Paper, aluminium tube $\frac{3}{4}$ in. dia. \times 2 $\frac{11}{16}$ in., tropical.
	<i>or</i>		
10C/11836	Type 3631		0.1 + 0.1 $\mu\text{F.}$, \pm 15 per cent, 350 volts DC working. Paper, $\frac{3}{4}$ in. dia. \times 2 $\frac{11}{16}$ in., tropical.

<i>Ref. No.</i>	<i>Nomenclature</i>	<i>Ref. in Fig. 1</i>	<i>Description</i>
	Receiver, Type R.1481		
	Condensers— <i>Contd</i>		
10C/3401	Type 1664	C57, 59	0.5 μ F., \pm 15 per cent, 350 volts DC working. Paper, aluminium tube, $\frac{3}{4}$ in. dia. \times $2\frac{15}{16}$ in., insulated, tropical.
10C/2599	Type 1229	C51	25 μ F., + 0 per cent — 10 per cent, 25 volts DC working. Electrolytic, aluminium tube, $\frac{3}{4}$ in. dia. \times $2\frac{3}{4}$ in., tropical.
	Covers:—		
10A/11821	Type 6		17 in. \times $10\frac{1}{2}$ in. \times 10 in. approx. \times $\frac{1}{4}$ in. For R.1481 with aluminium front panel.
	<i>or</i>		
10A/13259	Type 81		17 in. \times $10\frac{3}{16}$ in. \times 10 in. approx. \times $\frac{3}{32}$ in. For R.1481 with steel front panel.
10D/13278	Discs, insulating		Tufnol, $1\frac{3}{16}$ in. O/D \times 0.640 in. I/D \times $1\frac{1}{2}$ in. Drilled 2 holes 0.120 in. dia.
10A/11822	Drives, slow motion, Type 5		Double reducing gear, with pointer.
10D/13279	Earthing bridge assemblies		S.R.B.P. with 5 tags and metal bracket.
10D/7	Escutcheons, moulded		Black bakelite, $3\frac{1}{2}$ in. outside radius.
	Including:—		
10D/13280	1-window, escutcheon		
	Holders, valve:—		
10H/493	Type 73		I.O., moulded, with metal plate insert, $1\frac{1}{2}$ in. fixing centres.
10H/499	Type 75		B4(5). Moulded, with metal plate insert, $1\frac{1}{2}$ in. fixing centre.
10H/1739	Jacks, Type 1	J1-2	Telephone, bare.
	Knobs:—		
10A/11824	Type 7		Moulded, black. Slipping clutch type, with small handle.
10A/11836	Type 8		Moulded, black, instrument pointer with recess for drive pins. For $\frac{1}{4}$ in. dia. spindle.
10A/12768	Type 72		Moulded, black, $1\frac{1}{4}$ in. dia. fluted with stop level. For $\frac{1}{4}$ in. spindle.
10A/11000	Milliammeters, MC.0-5	M	2 in. dia. dial, square flange, flush moulded case, DC
10V/30	Oscillator units, Type 24	B0	Beat oscillator in rectangular metal case—without valve.
	Including:—		
10A/13025	1-cap, valve, Type 13		Top cap clip semi-circular spring.
10C/2082	1-Condenser, Type 972	C64	2- $6\frac{1}{2}$, μ F. Air-speed variable, ceramic base, 2 moving and 2 fixed vanes, $\frac{3}{4}$ in. \times $\frac{1}{4}$ in. dia. spindle.
10C/3397	1-Condenser, Type 1661	C65	80 μ F., \pm 15 per cent, 500 volts DC working. Tubular, end wires.
10C/2076	1-Condenser, Type 966	C66	300 μ F., + 15 per cent, 350 volts DC working. Moulded, mica, stacked foil.
10C/11138	3-Condensers, Type 3374	C67-9	0.01 μ F., \pm 20 per cent, 375 volts DC working. Paper, tubular, end wires.
10D/954	1-Core, iron dust, B.6826		7.75 mm. dia. \times 17 mm. 1.25 mm. pitch. Slotted end.
10H/493	1-Holder, valve, Type 73		I.O. Moulded, with metal plate insert, $1\frac{1}{2}$ in. fixing centres.

<i>Ref. No.</i>	<i>Nomenclature</i>	<i>Ref. in Fig. 1</i>	<i>Description</i>
	Receiver, Type R.1481		
	Oscillator units, Type 2A— <i>Contd.</i>		
10W/542	1-Resistance, Type 808	R54	22,000 ohms, ± 10 per cent, $\frac{1}{4}$ watt, insulated, end wires.
10W/546	1-Resistance, Type 809	R53	47,000 ohms, ± 10 per cent, $\frac{1}{4}$ watt, insulated, end wires.
10W/11499	1-Resistance, Type 487	R55	100,000 ohms, $+ 10$ per cent, $\frac{1}{4}$ watt, insulated, end wires.
10A/13933	1-Tagboard, Type 47		S.R.B.P. with 4 tags.
10H/301	Plugs:— Screwed		Moulded, knurled head. Screwed $\frac{1}{2}$ in. dia. \times 26 T.P.I.
10H/426	Type 206	P2	6-pole, flat pins with circular locating pin. Moulded chassis mounting, long, brackets, $2\frac{5}{16}$ in. fixing centres. No cover.
10H/1523	Type 360 <i>or</i>		6-pole, flat pins with circular locating pin. Moulded.
	Résistances:—		
10W/540	Type 806	R59, 60	47 ohms, ± 10 per cent, $\frac{1}{4}$ watt, insulated, end wires.
10W/11685	Type 498	R14, 22, 25	100 ohms, ± 10 per cent, $\frac{1}{4}$ watt, insulated, end wires.
10W/1342	Type 1342	R56-7-8	220 ohms, ± 10 per cent, $\frac{1}{4}$ watt, insulated, end wires.
10W/1108	Type 1108	R8	620 ohms, ± 5 per cent, $\frac{1}{4}$ watt, insulated, end wires.
10W/11667	Type 500	R41, 43	1,000 ohms, ± 10 per cent, $\frac{1}{4}$ watt, insulated, end wires.
10W/691	Type 875	R12, 19, 21, 31	2,200 ohms, ± 10 per cent, $\frac{1}{4}$ watt, insulated, end wires.
10W/948	Type 975	R44	4,700 ohms, ± 10 per cent, $\frac{1}{4}$ watt, insulated, end wires.
10W/546	Type 809	R16	47,000 ohms, ± 10 per cent $\frac{1}{4}$ watt, insulated, end wires.
10W/1076	Type 1076	R20, 27, 39	68,000 ohms, ± 10 per cent, $\frac{1}{4}$ watt, insulated, end wires.
10W/11499	Type 487	R18, 33, 38, 40	100,000 ohms, ± 10 per cent, $\frac{1}{4}$ watt, insulated, end wires.
10W/1399	Type 1399	R17, 23, 34	220,000 ohms, ± 20 per cent, $\frac{1}{4}$ watt, insulated, end wires.
10W/1476	Type 1476	R15, 24, 26, 32, 35-7, 42	330,000 ohms, ± 10 per cent, $\frac{1}{4}$ watt, insulated, end wires.
10W/539	Type 805	R61	47,000 ohms, ± 10 per cent, $\frac{1}{2}$ watt, insulated, end wires.
10W/11623	Type 490	R11	10,000 ohms, ± 10 per cent, 2 watts, non-insulated.
10W/1567	Type 1567	VR1	100 ohms, ± 20 per cent, potentiometer. Wire wound, linear, tags, slider earthed to case, $\frac{1}{2}$ in. \times $\frac{1}{4}$ in. dia. spindle, slotted.

Ref. No.	Nomenclature	Ref. in Fig. 1	Description
	Receiver, Type R.1481		
	Oscillator units, Type 24— <i>Contd.</i>		
10W/542	1-Resistance, Type 808	R54	22,000 ohms, ± 10 per cent, $\frac{1}{4}$ watt, insulated, end wires.
10W/546	1-Resistance, Type 809	R53	47,000 ohms, ± 10 per cent, $\frac{1}{4}$ watt, insulated, end wires.
10W/11499	1-Resistance, Type 487	R55	100,000 ohms, ± 10 per cent, $\frac{1}{4}$ watt, insulated, end wires.
10A/13933	1-Tagboard, Type 47		S.R.B.P. with 4 tags.
10H/301	Plugs:— Screwed		Moulded, knurled head. Screwed $\frac{1}{2}$ in. dia. \times 26 T.P.I.
10H/426	Type 206	P2	6-pole, flat pins with circular locating pin. Moulded chassis mounting, long brackets, $2\frac{5}{16}$ in. fixing centres. No cover.
10H/1523	Type 360 <i>or</i>		6-pole, flat pins with circular locating pin. Moulded.
	Resistances:—		
10W/540	Type 806	R59, 60	47 ohms, ± 10 per cent, $\frac{1}{4}$ watt, insulated, end wires.
10W/11685	Type 498	R14, 22, 25	100 ohms, ± 10 per cent, $\frac{1}{4}$ watt, insulated, end wires.
10W/1342	Type 1342	R56-7-8	220 ohms, ± 10 per cent, $\frac{1}{4}$ watt, insulated, end wires.
10W/1108	Type 1108	R8	620 ohms, ± 5 per cent, $\frac{1}{4}$ watt, insulated, end wires.
10W/11667	Type 500	R41, 43	1,000 ohms, ± 10 per cent, $\frac{1}{4}$ watt, insulated, end wires.
10W/691	Type 875	R12, 19, 21, 31	2,200 ohms, ± 10 per cent, $\frac{1}{4}$ watt, insulated, end wires.
10W/948	Type 975	R44	4,700 ohms, ± 10 per cent, $\frac{1}{4}$ watt, insulated, end wires.
10W/546	Type 809	R16	47,000 ohms, ± 10 per cent $\frac{1}{4}$ watt, insulated, end wires.
10W/1076	Type 1076	R20, 27, 39	68,000 ohms, ± 10 per cent, $\frac{1}{4}$ watt, insulated, end wires.
10W/11499	Type 487	R18, 33, 38, 40	100,000 ohms, ± 10 per cent, $\frac{1}{4}$ watt, insulated, end wires.
10W/1399	Type 1399	R17, 23, 34	220,000 ohms, ± 20 per cent, $\frac{1}{4}$ watt, insulated, end wires.
10W/1476	Type 1476	R15, 24, 26, 32, 35-7, 42	330,000 ohms, ± 10 per cent, $\frac{1}{4}$ watt, insulated, end wires.
10W/539	Type 805	R61	47,000 ohms, ± 10 per cent, $\frac{1}{2}$ watt, insulated, end wires.
10W/11623	Type 490	R11	10,000 ohms, ± 10 per cent, 2 watts, non-insulated.
10W/1567	Type 1567	VR1	100 ohms, ± 20 per cent, potentiometer. Wire wound, linear, tags, slider earthed to case, $\frac{1}{2}$ in. \times $\frac{1}{4}$ in. dia. spindle, slotted.

Ref. No.	Nomenclature	Ref. in Fig. 1	Description
	Receiver, Type R.1481		
10K/1951	Transformer units, Type 101	IFT4	4th IF screened case, 1.87 in. dia. × 3 in. high.
	Including:—		
10C/4922	2-Condensers, Type 2612	C44, 46	30 $\mu\mu\text{F.}$, $\pm 1 \mu\mu\text{F.}$, 350 volts DC working. Silvered mica, protected type.
10C/96	2-Condensers, Type 611	C47-8	100 $\mu\mu\text{F.}$, ± 15 per cent, 350 volts DC working. Mica, moulded, end wires.
10D/956	2-Cores, iron dust, S34A		7.75 mm. dia. × 16 mm. threaded 1.25 mm. pitch. Slotted end.
10W/546	2-Resistances, Type 809	R28-9	47,000 ohms, ± 10 per cent, $\frac{1}{4}$ watt, insulated, end wires.
10D/17427	Tuning unit, Type 164		RF screened sub-assembly, less drive, scale escutcheon and valves.
	Includes:—		
10A/13092	Caps, valve Type 16		Brass, silver plated, grid clip, looped $\frac{1}{32}$ in. × $\frac{5}{16}$ in.
	Condensers:—		
10C/2072	Type 962	C2, 9, 15, 22	2-8 $\mu\mu\text{F.}$, air-spaced variable trimmer, die cast, cylindrical.
10C/2069	Type 959	C3	3-18 $\mu\mu\text{F.}$, air-spaced variable ceramic insulation, metal frame, 1 in. × $1\frac{1}{2}$ in. × 1.38 in. deep. 4 moving, 3 fixed vanes. No rear spindle.
10C/2071	Type 961	C10, 11	3-18 $\mu\mu\text{F.}$, 2-gang air-spaced variable ceramic insulation, metal frame 2 in. × $1\frac{1}{2}$ in. × 1.38 in., 4 moving and 3 fixed vanes, $\frac{1}{4}$ in. dia. spindle both ends.
10C/2070	Type 960	C21	3-20 $\mu\mu\text{F.}$, air-spaced variable, ceramic insulation, frame as Type 959. Four moving and 4 fixed vanes, $\frac{1}{4}$ in. dia., spindle both ends.
10C/3219	Type 1573	C1, 4, 73	5 $\mu\mu\text{F.}$, $\pm 0.5 \mu\mu\text{F.}$, 500 volts DC working. Ceramic tube, end wires, negative coefficient.
10C/2073	Type 963	C17	10 $\mu\mu\text{F.}$, $\pm 0.5 \mu\mu\text{F.}$, 500 volts DC working. Ceramic tube, end wires, negative coefficient.
10C/2075	Type 965	C6	30 $\mu\mu\text{F.}$, $\pm 0.25 \mu\mu\text{F.}$, 500 volts DC working. Ceramic tube, end wires, negative coefficient.
10C/3397	Type 1661	C8, 20	80 $\mu\mu\text{F.}$, ± 15 per cent, 500 volts DC working. Ceramic tube, end wires, negative coefficient.
10C/963	Type 895	C72	100 $\mu\mu\text{F.}$, ± 10 per cent, 350 volts DC working. Mica, stacked foil.
10C/2076	Type 966	C12	300 $\mu\mu\text{F.}$, ± 15 per cent, 350 volts DC working. Moulded, mica, end wires, midget.
10C/4502	Type 2328	C5, 7, 14, 23, 24	1,000 $\mu\mu\text{F.}$, + ∞ — 25 per cent, 350 volts DC working. Moulded, mica, end wires.
10C/11138	Type 3374	C13, 18, 19	0.01 $\mu\text{F.}$, ± 20 per cent, 375 volts DC working. Paper, tubular, end wires.

<i>Ref. No.</i>	<i>Nomenclature</i>	<i>Ref. in Fig. 1</i>	<i>Description</i>
Tuning unit, Type 164—(Contd.)			
10A/12380	Couplings, Type 5		Flexible, for $\frac{1}{4}$ in. dia. spindle.
10H/491	Holder, valve, Type 72		B.O. moulded, with metal plate insert, $1\frac{1}{2}$ in. fixing centres.
	Inductances:—		Copper wire coils, 14 S.W.G., silver plated:—
10C/13054	Type 877	L2, 3	4 turns, $\frac{1}{8}$ in. pitch, $\frac{1}{2}$ in. dia. mandrel.
10C/13055	Type 878	L1	3 turns, $\frac{1}{8}$ in. pitch, $\frac{5}{8}$ in. dia. mandrel.
10C/13056	Type 879	L4	2 turns, $\frac{1}{8}$ in. pitch, $\frac{5}{8}$ in. dia. mandrel.
	Resistances:—		
10W/540	Type 806	R59, 60	47 ohms, ± 10 per cent, $\frac{1}{4}$ watt, insulated, end wires.
10W/1564	Type 1564	R4	160 ohms, ± 5 per cent, $\frac{1}{4}$ watt, insulated, end wires.
10W/1108	Type 1108	R8	620 ohms, ± 5 per cent, $\frac{1}{4}$ watt, insulated, end wires.
10W/691	Type 875	R5	220 ohms, ± 10 per cent, $\frac{1}{4}$ watt, insulated, end wires.
10W/948	Type 975	R1, 3	4,700 ohms, ± 10 per cent, $\frac{1}{4}$ watt, insulated, end wires.
10W/1565	Type 1565	R10	18,000 ohms, ± 10 per cent, $\frac{1}{4}$ watt, insulated, end wires.
10W/546	Type 809	R9	47,000 ohms, ± 10 per cent, $\frac{1}{4}$ watt, insulated, end wires.
10W/11499	Type 487	R2, 6, 7	100,000 ohms, ± 10 per cent, $\frac{1}{4}$ watt, insulated, end wires.
10H/10330	Sockets, Type 56	P1	S.P. coaxial, panel mounting.
	Valves:—		
10CV/1053	CV.1053	V5-8	I.O. metallized, variable- μ screened pentode.
10C/1054	CV.1054	V9	I.O. metallized, double diode.
10CV/1057	CV.1057	V10	I.O. top grid, metallized, octode.
10CV/1065	CV.1065	V1, 2	Mazda octal, top grid, metallized, screened pentode, 6.3-volt heater.
10CV/1066	CV.1066	V3	Mazda octal, metallized, triode.
10CV/1067	CV.1067	V11	I.O. clear glass, triode.
10CV/1070	CV.1070	V4	B4, clear glass, gas-filled stabilizer.
	Accessories—Items to be specified as required		
10D/296	Cases, transit (R.1132A R.1481, R.1526)		Wood.
	Tools, tuning:—		Bakelised fabric:—
10A/13506	Coil		$\frac{3}{8}$ in. \times $\frac{5}{8}$ in. \times 5 in., with wedge and forked ends. To vary spacing of turns.
10A/13505	Trimmer		$7\frac{1}{2}$ in. \times $\frac{1}{2}$ in. dia., tapered to $\frac{1}{4}$ in. dia. Screwdriver and hexagon ends.
	Associated test equipment—Items to be specified as required		
10S/11934	Output meters, Type 2		0.1 to 5,000 milliwatts.
10SB/17	Signal generators, Type 12		Adaptable for mains or battery supply.

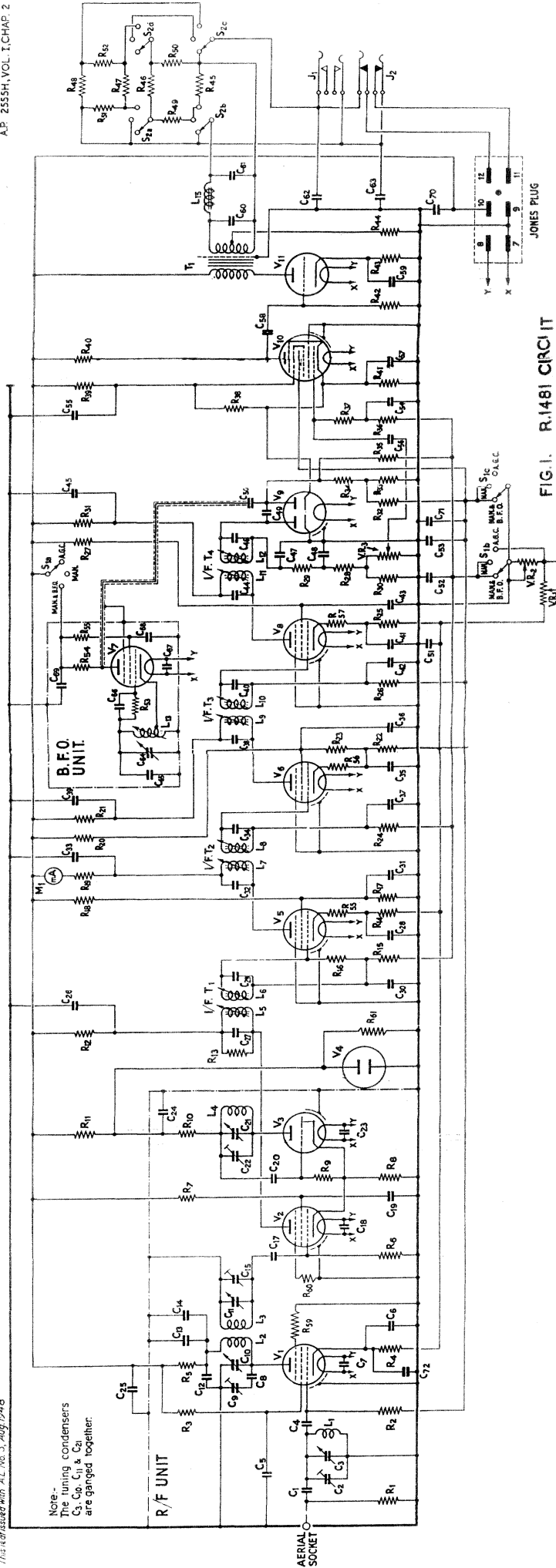

FIG. 1. R.1481 CIRCUIT

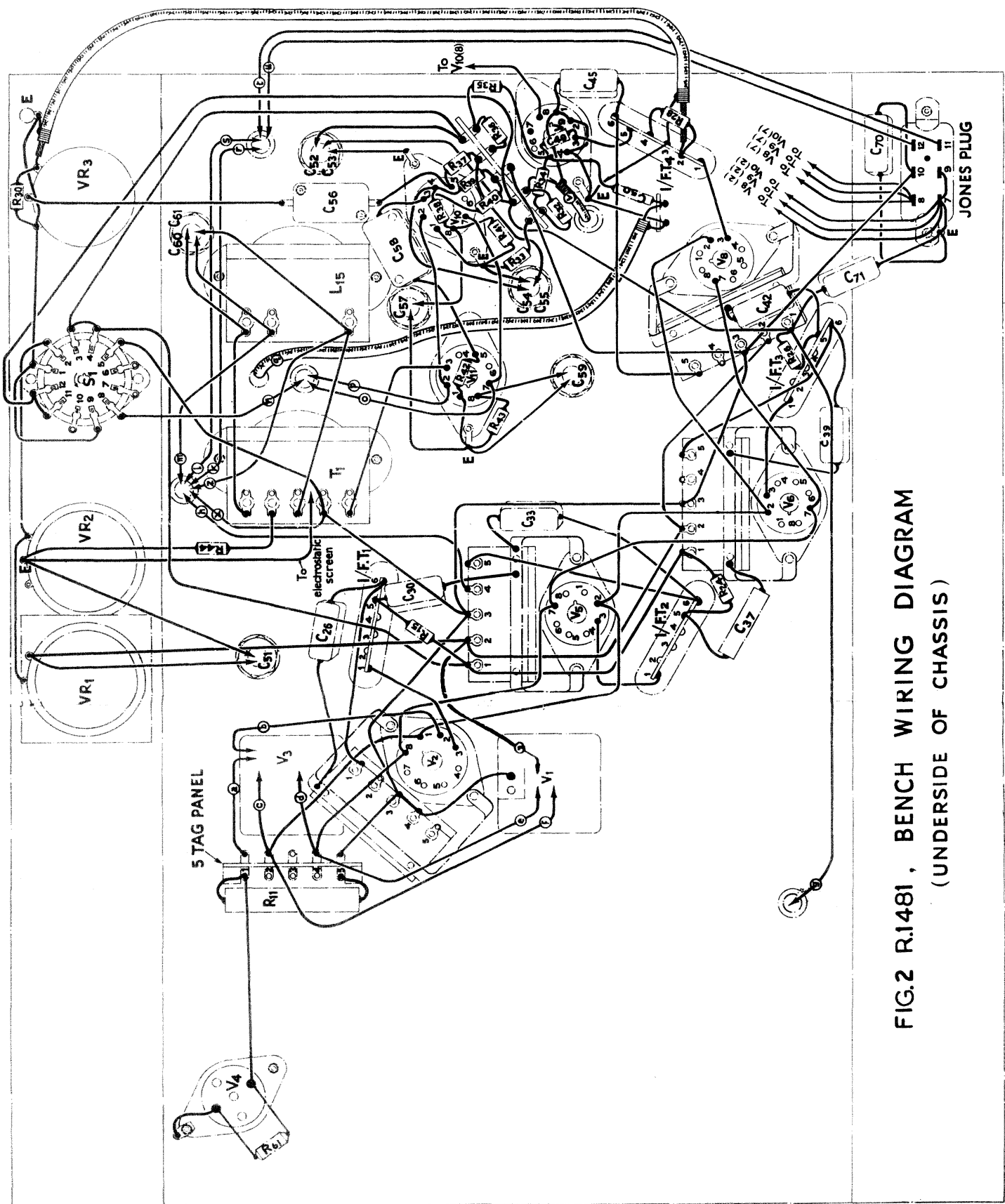

FIG. 2 R.1481, BENCH WIRING DIAGRAM
(UNDERSIDE OF CHASSIS)